



MARINE TRAINING SOFTWARE, SIMULATORS AND DIESEL ENGINE TESTERS

**MARINE TRAINING
SOFTWARE
Engineering CBT**

Operator's Handbook

Part 3

36 Jednorożca St.
80-299 Gdańsk Osowa
POLAND
tel./fax +48 58 5525739
e-mail: office@unitest.pl
www.unitest.pl

NIP 584-102-93-70
REGON 2880985

BANK:
MILLENNIUM S.A.
Al. Jerozolimskie 123a
02-017 Warszawa, POLAND
Account number:
48 1160 2202 0000 0000 5069 4371

Contents

Installation instruction.....	4
MARINE PUMPS.....	5
1. General description.....	5
2. Operating principles.....	7
FRESHWATER GENERATOR.....	11
1. General description.....	11
2. Working principles.....	14
3. Operating procedures.....	14
REVERSE OSMOSIS DESALINATION SYSTEM.....	17
1. Introduction.....	17
2. Description.....	17
3. Control Panel Description.....	22
4. Starting Procedure.....	23
5. Shutdown Procedure.....	24
6. Storage & Cleaning Procedure.....	24
7. Filter's cleaning procedure.....	26
S-TYPE SEPARATION SYSTEM.....	27
1. System Overview.....	27
2. Oil flow.....	28
3. System layout.....	29
4. Control panel description.....	31
5. Process Principles.....	32
6. Process Cycle Start.....	32
7. Discharge.....	33
8. Increased Water Content.....	33
9. Manual Operation.....	34
10. During Operation.....	36
11. Stop.....	38
COMBINED OIL FIRED AND EXHAUST GAS BOILER.....	39
1. Introduction.....	39
2. Description.....	39
3. Simulator.....	48
4. Operating procedures.....	53

REMOTE CONTROL SYSTEM FOR SULZER RTA ENGINES	57
1. General description.....	57
2. Remote Control System AUTOCHIEF-4	57
3. Engine Control System (diesel engine interface) DENIS -1.....	73
4. Operating procedures.....	79
5. Step-by-step Mode.....	83
REMOTE CONTROL SYSTEM FOR MAN B&W LMC ENGINES	86
1. General description.....	86
2. Remote Control System AUTOCHIEF-4	86
3. Engine Control System ZSPB -32	101
4. Operating procedures.....	106
5. Step-by-Step Mode	109
REFRIGERATION PLANT.....	112
1. General description.....	112
2. Operating instruction	119
3. Starting procedure	120
4. Continuous running procedure	122
5. Stopping procedure.....	124
6. Cold chamber 1 defrosting procedure.....	124
7. Low suction pressure (p_s) setting procedure	125
8. Maximum compression pressure (p_t) setting procedure	126
9. Differential pressure control DPC setting procedure	126
10. Cold chamber temperature setting procedure.....	127

Installation instruction

1. Do not insert the Hardlock Key before the software installation!
2. Start the computer and load the Windows 98 / Me / 2000 / XP / 2003 / Vista operating system.
3. Please wait for the CD-ROM auto-start sequence, or:
 - a. Insert the CD into the CD-ROM drive.
 - b. Click the “Start” menu.
 - c. Select “Run...”.
 - d. Type “[CD-ROM drive letter]:\setup.exe” (e.g. d:\setup.exe), or click ‘Browse...’ button and locate ‘setup.exe’ file on the CD-ROM.
 - e. Click “OK” button.
4. Follow the instructions shown on the screen.
5. After the installation has completed, please insert the Hardlock Key.
6. In order to read the manual pdf files, please install the “Adobe Reader”, which is included on the CD-ROM.

MARINE PUMPS

1. General description

The educational program MARINE PUMPS is intended for teaching the basic principles of how to operate a typical water pumps installation used in marine and industrial power plants.

The program is based on an installation with two centrifugal pumps. Each of the pumps can function either individually either in parallel or serial operation.

The following elements are incorporated in the installation /fig.1/:

1. Tank No 1 (lower tank)
2. Tank No 2 (upper tank)
3. Two centrifugal pumps
4. Control panel with:
 - push-buttons:
 - 'START' - manual operation
 - 'STOP'
 - 'AUTO' - automatic operation
 - tanks No 1 and 2 indication and alarm lamps:
 - 'ALARM HIGH LEVEL' (red)
 - 'HIGH LEVEL' (yellow)
 - 'LOW LEVEL' (yellow)
 - 'ALARM LOW LEVEL' (yellow)
5. Fittings (valves, pressure gauges, level gauges, remote control valve, flow-meter)

Graphic symbols which are used in the water pump installation diagram are described in the legend /fig.2/.

On the diagram:

- blue colour indicates water
- white colour indicates the absence of water flow in the pipe and the presence of air inside the pipelines.

The valves on the diagram are active i.e. their opening and closing is operated by mouse clicking in the rectangle's field. On the inlet pipe supplying water to Tank No 2 the valve with regulating opening ratio is placed. This valve makes possible the simulation of changes of the pipeline characteristics. The increase of valve opening ratio is done by mouse clicking in the upper arrow field. In order to decrease the valve opening ratio click in the lower arrow

field. The valve opening ration is displayed in the form of percentage (100% - valve totally open, 0% - valve totally closed).
 The upper and lower tanks are equipped with level gauges (hydrostatic type).

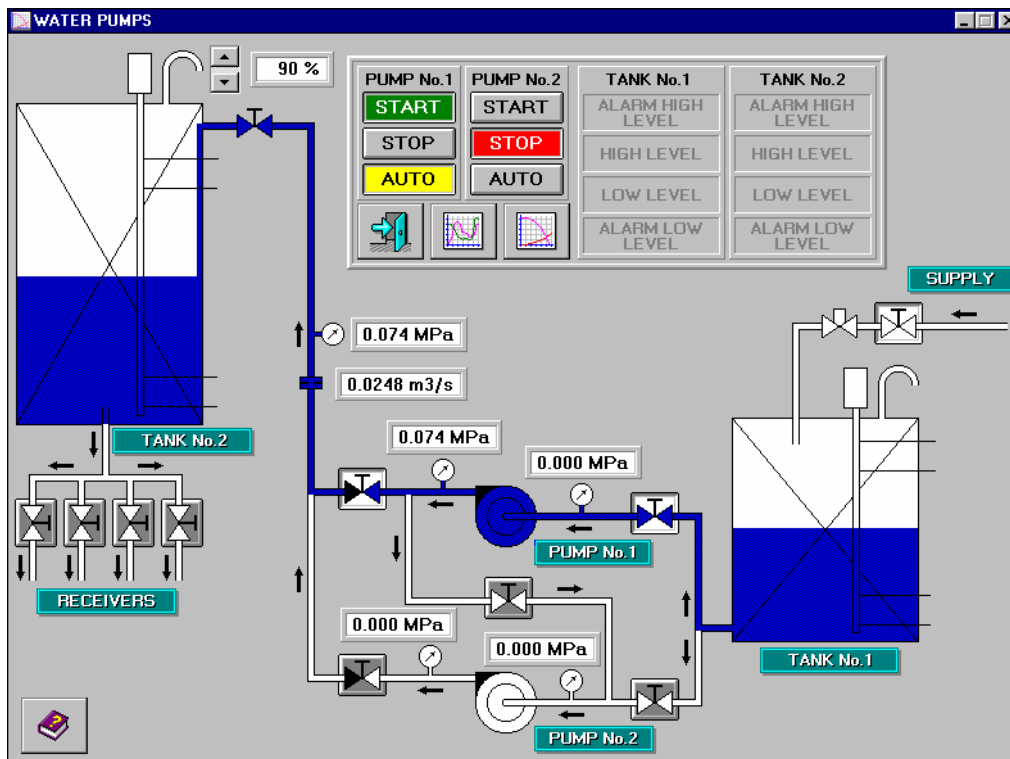

Fig. 1 Water pumps plant diagram

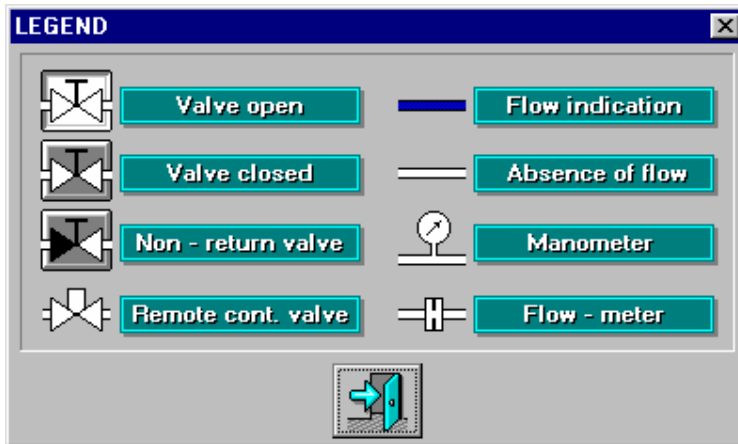

Fig. 2 Legend

2. Operating principles

The pumps may be operated manually (by pressing push-buttons 'START' - confirmed by a green light and 'STOP' - confirmed by red light) or function automatically (by pressing push-button 'AUTO' -confirmed by yellow light).

If the pump functions automatically ('AUTO'), it will start at low water level in Tank No 2 (this level is marked on the level gauge 'LOW LEVEL') and stop at high water level 'HIGH LEVEL'.

The lamp on the control panel lights when determined levels are reached: 'HIGH LEVEL' and 'LOW LEVEL' - yellow lamp lights; 'ALARM HIGH LEVEL' and 'ALARM LOW LEVEL' - red lamp.

The valves supplying water to the receivers are placed in the lower part of Tank No 2.

In the event that all the valves to the receivers are open, the water decrement is so considerable that one pump only is not able to refill water in the tank. Thus, it will be necessary to start the second pump as a parallel one.

Tank No 2 fills automatically (by means of remote control valve and level gauge)

Attention:

Tank No 1 starts filling only when the inlet valve is opened.

The three icons placed below the pumps push buttons on the control panel have the following purpose:

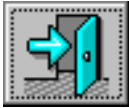

Exit

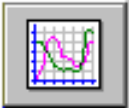

Parameters time diagram



Pump and pipeline characteristics - point of work

The parameters time diagram /fig. 3/ enables the observation of the following parameters' change:

- Pt - pump discharge pressure (MPa)
- Q - intensity of water flow (m^3/s)

These parameters (Pt and Q) may be observed separately or simultaneously (icon marked with red cross indicates presentation of the particular parameter on the time diagram).

The pump and pipeline characteristics /fig. 4/ are presented as H-Q diagram (H - pressure head in meters fluid column).

It is possible to obtain the pump and pipeline characteristics only during pump operation. Parameters time diagrams and pump and pipeline characteristics diagrams may be printed.

Remaining icons description



Legend



Pump discharge pressure time diagram

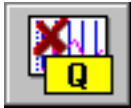

Intensity of water flow time diagram



Print

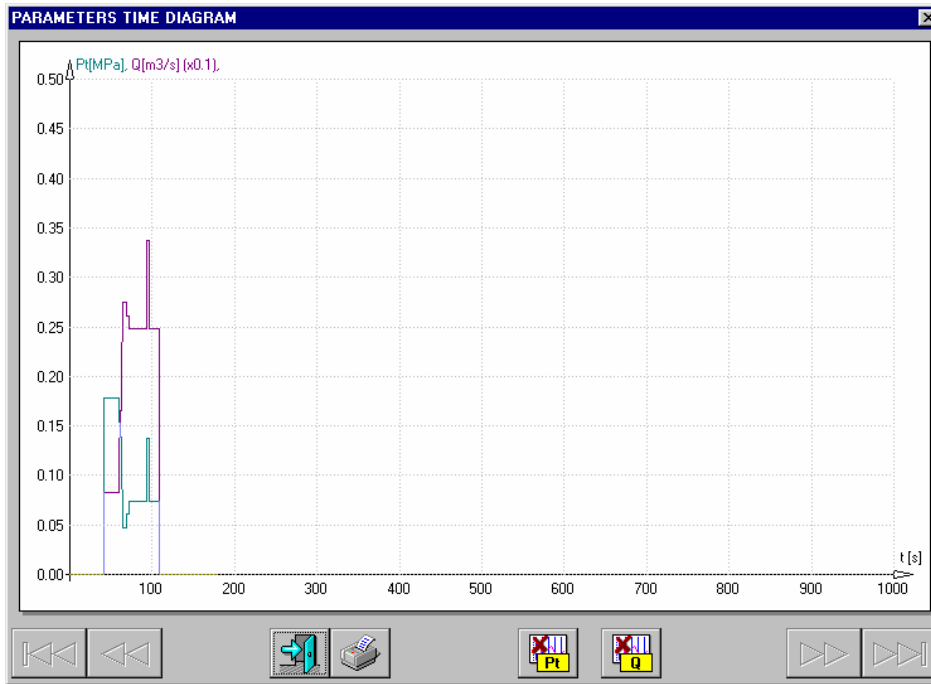

Fig. 3 Parameters time diagram

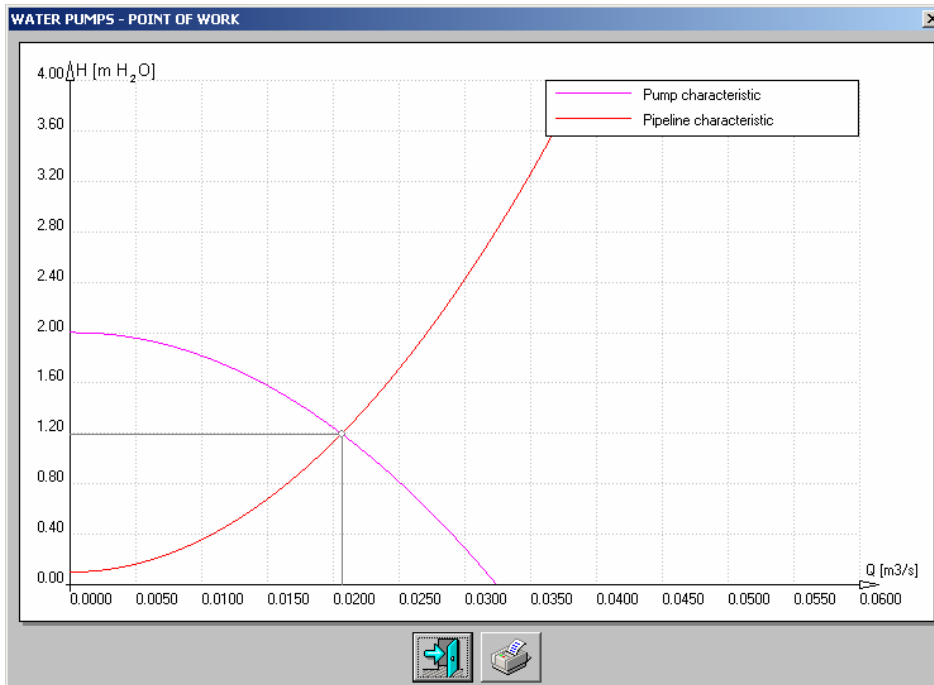

Fig. 4 Pump and pipeline characteristic – point of work

FRESHWATER GENERATOR

1. General description

The freshwater generator - vacuum evaporator consists of the following main components:

1. Separator vessel /fig. 2/ with:
 - evaporator section /plate heat exchanger/
 - demister
 - condenser section /plate heat exchanger/
 - fittings / air valve, safety valve, vacuum gauge, thermometer and sight glass/
2. Combined air/brine ejector /fig. 2/
3. Ejector pump /fig. 2/
4. Freshwater pump /fig. 2/
5. Control panel with salinometer and Engine Control Room's alarm block /fig. 1/:
 - ON/OFF 'MAIN SWITCH' with 'SOURCE ON' lamp,
 - ON/OFF push-buttons for ejector pump and freshwater pump,
 - salinometer DS-20 control panel
 - Engine Control Room's alarm block with alarm lamp and 'ALARM CONFIRMATION' button.

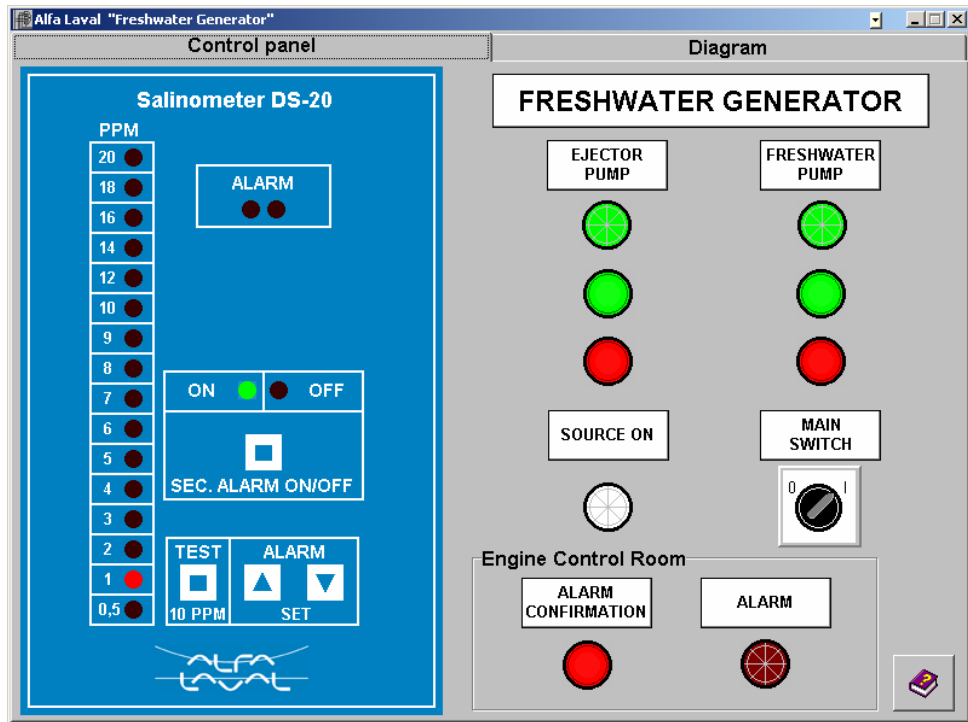

Fig. 1 Freshwater generator plant Control panel

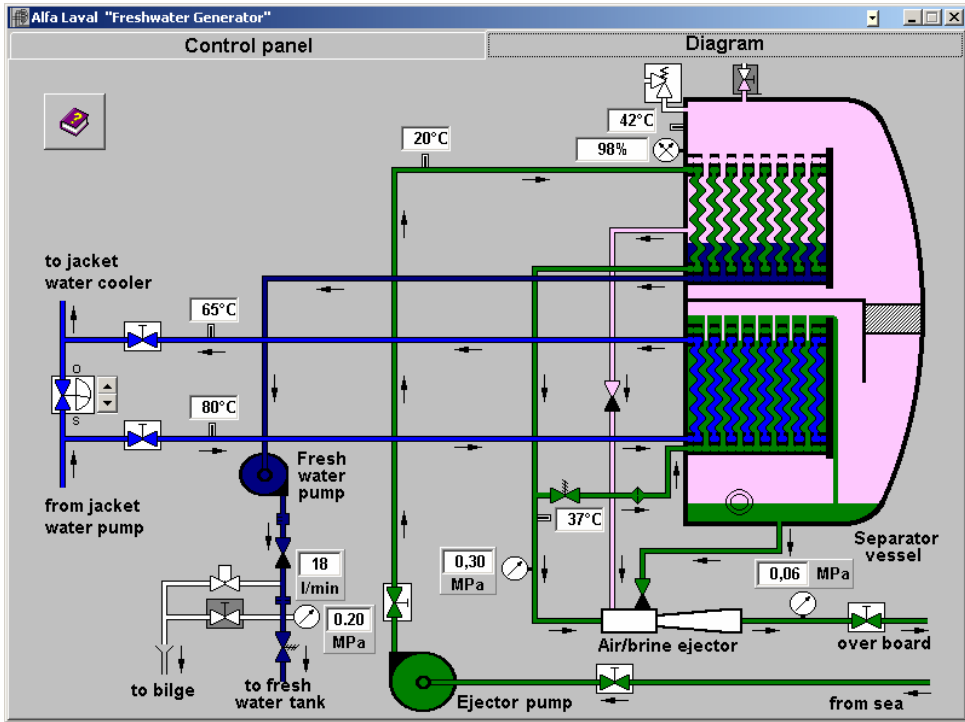

Fig. 2 Freshwater generator plant diagram

Graphic symbols which are used in freshwater generator diagram are described in the legend /fig. 3/.

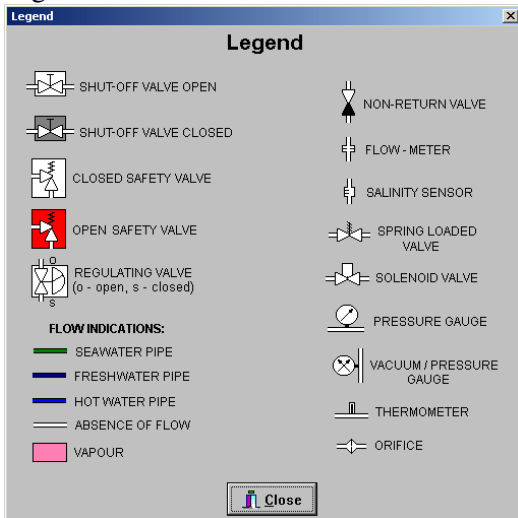

Fig. 3 Freshwater generator – legend

2. Working principles

The feed water to be distilled is taken from the sea cooling water outlet of the condenser. It enters the evaporator where it evaporates at about 40-50°C as it passes between the plates heated by the heating medium.

The evaporating temperature corresponds to a vacuum of 90-95%, maintained by the brine/air ejector. The vapours generated pass through a demister where any drops of seawater entrained are removed and fall due to gravity to the brine sump in the bottom of the generator chamber. The clean freshwater vapours continue to the condenser, where they condense into freshwater as they pass between the cold plates cooled by the sea cooling water.

In order to check continuously the quality of the produced freshwater, a salinometer is provided together with an electrode unit fitted on the freshwater pump delivery side. If the salinity of the produced freshwater exceeds the permitted maximum value (2 ppm), the solenoid valve and alarm are activated to dump automatically the produced freshwater to the bilge.

3. Operating procedures

Starting procedure:

1. Open valves on the suction and discharge side of the ejector pump.
2. Open overboard valve for combined air/brine ejector.
3. Close air valve on the upper part of the separator vessel.
4. Set up the Main switch into position 1.
5. Start ejector pump. Check the pressure before ejector - min. 0,28 - 0,3 MPa after ejector - max 0,06 MPa.
6. When there is a minimum of 90% vacuum, open hot water inlet and outlet valves /from jacket cooling system/.
7. Start hot water supply to evaporator section by adjusting by-pass valve, until the desired jacket water temperature is reached / inlet 80 °C, outlet 72 °C/ The boiling temperature inside the separator vessel should be about 45 °C.

Attention:

Improper hot water flow /adjust by by-pass / will cause the following effects:

- a. in case the flow is too low- low boiling temperature, drop of freshwater production / high brine level in sight glass in separator vessel/
- b. in case the flow is too high - high boiling temperature, drop of freshwater production, increase of salinity and drop of vacuum /low brine level in sight glass in separator vessel /.

4. Start fresh water pump.
5. When the salinity level drops below the set alarm point, set the Sec. (secondary) alarm on.

Attention:

During the first few minutes, after freshwater pump starts, salinity of produced water may be higher than the set alarm point, thus it is recommended to dump it to bilge (solenoid valve on the discharge side of freshwater pump stays open). When evaporation starts, the boiling temperature rises, while the obtained vacuum drops to approx. 93%. After few minutes normal vacuum and boiling temperature is re-established, salinity drops below the set alarm point and solenoid valve closes.

Adjustment of alarm level:

1. Set up the Main switch into position 1.
2. Push “Sec. Alarm” off.
3. Adjust Alarm Set to desired alarm level by using arrows (alarm level is indicated by red flashing led).
4. Switch “Sec. Alarm” on.

The salinometer is now ready for use.

If the salinity exceeds the alarm level,

- The two red alarms LEDES flash.
- Solenoid valve is activated.
- Buzzer (if fitted) and external alarm system is activated.

Cancel buzzer and external alarm system by switching “Sec. Alarm” off. Solenoid valve is not affected.

Switch “Sec. Alarm” on as soon as the salinity is normal again; i.e. when the two red LEDES is off.

Stopping procedure:

1. Stop hot water supply to evaporator section.
2. Stop freshwater pump.
3. Set Sec. alarm off.
4. Stop ejector pump.
5. Set the Main switch into position 0.
6. Open air valve.
6. Close valves on the suction and discharge side of the ejector pump.
7. Close overboard valve for combined air/brine ejector.

REVERSE OSMOSIS DESALINATION SYSTEM

1. Introduction

The educational program REVERSE OSMOSIS DESALINATION SYSTEM is intended for teaching the basic principles of how to operate a typical Reverse Osmosis Desalination System.

The program is based on the installation SRC 15m³ SW/S1 produced by SEA RECOVERY corporation (U.S.A.).

The program consists of:

- Reverse Osmosis Desalination System Diagram
- Control Panel

2. Description

SEA RECOVERY's method is applied for water desalination. The purpose of the Reverse Osmosis Desalination System is to produce potable freshwater from seawater, by taking advantage of the osmosis phenomenon.

OSMOSIS: Osmosis can be defined as the spontaneous passage of a liquid from a more diluted solution to a more concentrated solution across an ideal semi-permeable membrane which allows for the passage of the solvent (water) but not the dissolved solids (salts). This process is caused by the existence of the osmotic pressure.

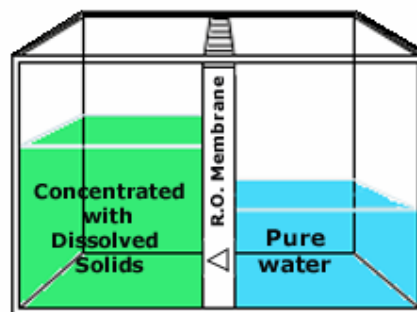

Fig. 1 Osmosis

OSMOTIC PRESSURE: The transfer of water from one side of the membrane to the other will continue until the head (pressure) is large enough to prevent any net transfer of the solvent (water) to the more concentrated solution. At equilibrium, the quantity of water passing in either direction is equal, and the pressure is then defined as the Osmotic Pressure of the solution having that particular concentration of dissolved solids.

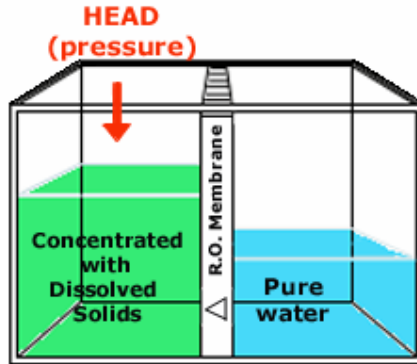

Fig.2 Osmotic Pressure

Reverse Osmosis Desalination System functions by taking advantage of the process that is the contrary of the natural osmosis, called reverse osmosis.

REVERSE OSMOSIS: As described above, water will continue to flow from the pure water side of the membrane to the saline solution side until the pressure created by the rise in water level on the saline solution side of the membrane equals the osmotic pressure. If the pressure of the saline solution is increased until it exceeds the osmotic pressure, water is forced to flow through the membrane from the solution containing the higher salt concentration into the solution with the lower salt concentration. The process is called Reverse Osmosis.

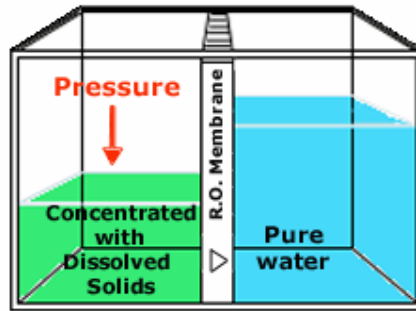

Fig.3 Reverse Osmosis

How it works (fig. 4)

Feed water (seawater) is pumped into the system via an seawater inlet valve (1), then filtered through a strainer (2). The pressure level of the seawater is then increased by the feed pump (5) and filtered once more through dual stage tight micron prefilters (7). Oil, if present, is now separated and removed through the optional oil/water separator (9). A low pressure switch (11) shuts down the system in the event of low flow condition. This prevents cavitation in the high pressure pump (13). The seawater flow is measured by the feed water flow meter (12) to ensure proper operation of the high pressure pump. The high pressure pump (13) forces the filtered seawater into the membrane vessel assembly (14). The back pressure regulator (17) controls and automatically maintains the necessary high pressure level in the membrane. Concentrated brine is discharged through the discharge connector (22).

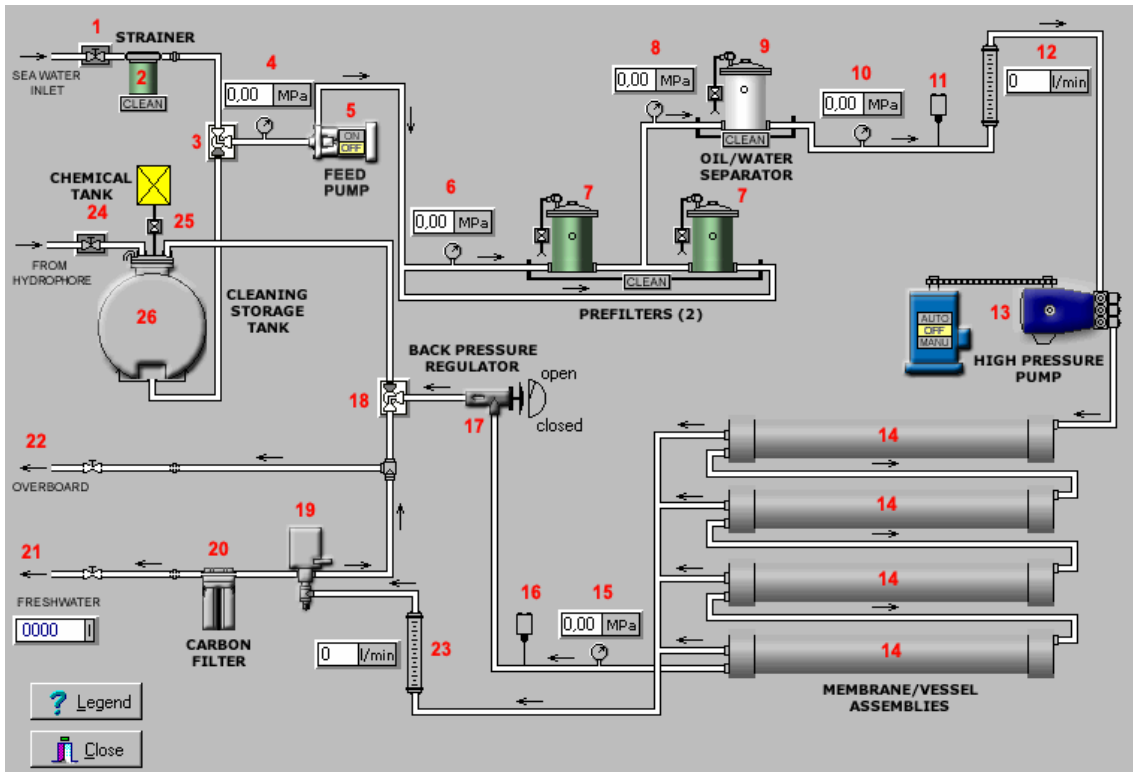

Fig. 4 Reverse Osmosis Desalination System Diagram

The freshwater flows out of the R.O. membrane and passes into a freshwater flow meter (23) where the amount of potable freshwater produced is registered. Next, the salinity probe (19) adjusts automatically for temperature changes and registers, electronically, the salt content of the freshwater. The freshwater then proceeds into the 3-way solenoid directional valve. Here, freshwater is diverted to the carbon filter where gases or odors present are absorbed and removed from the water.

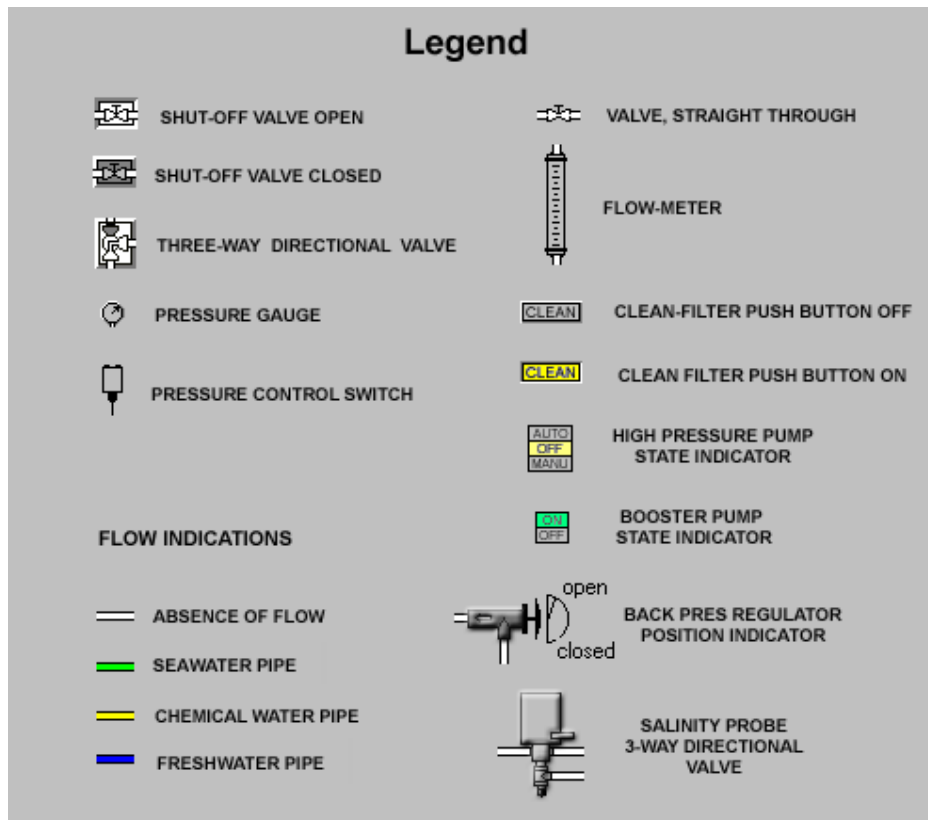

Fig. 5 Legend

3. Control Panel Description

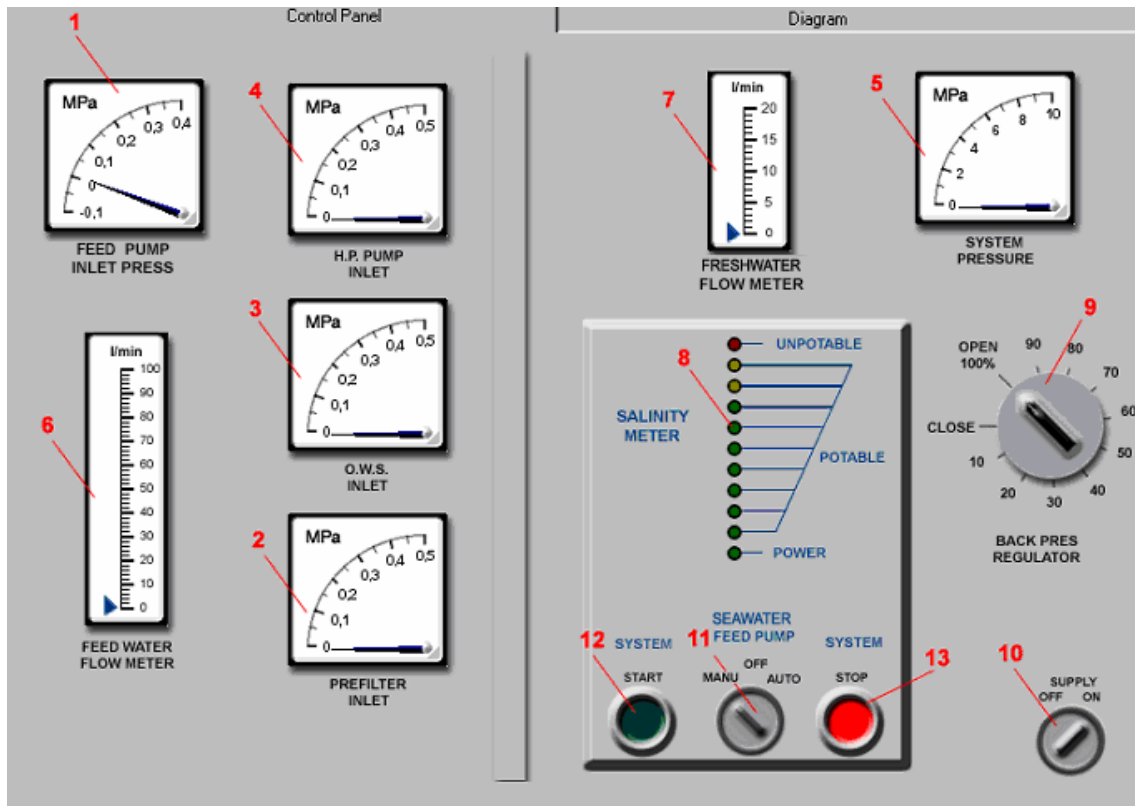

Fig. 4 Control Panel

Control Panel includes:

- a) Pressure Gauges:
 - Feed pump inlet pressure (1)
 - Prefilters inlet pressure (2)
 - Oil/water separator inlet pressure (3)
 - High pump inlet pressure (4)
 - System pressure (5)

- b) Flow meters:
 - Feed water flow meter (6)
 - Freshwater flow meter (7)

- c) Salinity meter (8)

- d) Back pressure regulator (9)
- e) 2-position, supply switch (10)
- f) 3-position, feed pump control switch (11)
- g) Push button „START” – system start (12)
- h) Push button „STOP” – system stop (13)

4. Starting Procedure

1. Close all system drain and air bleed valves.
2. Open the seawater inlet valve.
3. Position the feed source directional control valve 3 to the normal feed water operational position (should connect feed pump inlet with seawater supply source).
4. Open the back pressure regulator valve 17 fully (100% open).
5. Position the brine discharge directional control valve 18 to the normal operation position (from the back pressure regulator 17 to the brine discharge connection 22).
6. Open any and all auxiliary line valves leading to and from the Sea Recovery R.O. System.

CAUTION: Failure to open all lines to and from the Sea Recovery System will result in immediate damage to the Sea Recovery System at start up.

7. Switch the supply switch to position “ON”
8. If the system is started for the first time or after aeration it is necessary to :
 - a) Open the air bleed valve located at the left side of the respective filter housing. Air must be bled from the filters 7 and 9.
 - b) Switch the feed pump control switch to the “MANU” position which will start the feed pump until water displaces all of the air.
 - c) Switch the feed pump control switch to the “OFF” position.

CAUTION: In the "Manu" position the feed pump is controlled independently of the high pressure pump. In the "Auto" position the feed pump is started and stopped automatically together with the high pressure pump.

9. Switch the feed pump control switch to the “AUTO” position - this will cause the feed pump to start automatically when the system is started.
10. Press the system “START” switch and hold it until the low pressure gauge 10 (inlet high pressure pump) reads a minimum of 0.1 MPa.

If the low pressure gauge 10 registers below 0.1 MPa the low pressure protection switch 11 will automatically stop the system when the start switch is released.

11. If feed water pressure increases to above 0.1 MPa the system should be running and water will be passing through the seawater flow meter. Any air passing through the meter will cause incorrect reading.
12. When feed water flow will be proper about 40 l/min, slowly increase the pressure in the system (after high pressure pump) by turning the back pressure regulator until pressure of 4.2 MPa is achieved.
13. With 4.2 MPa operating pressure, the system will pass seawater through the R.O. membrane element 14.
14. Continue adjusting the back pressure regulator 17 slowly until pressure reaches 5.2 to 5.6 MPa. Do not operate the system above 6 MPa.
15. The system running, properly interconnected and pressurized, may not produce “Potable” freshwater for up to 30 minutes after start.

5. Shutdown Procedure

1. Release the operating pressure in the system by turning the back pressure regulator fully open (100% open).
2. Press the “STOP” switch on the salinity controller to shut down the system. Check to ensure that the high pressure pump 13 and the feed pump 5 have stopped rotating.
3. Immediately after stopping the system, close the seawater inlet valve 1.
4. Turn supply switch to the “OFF” position.
5. Proceed to STORAGE & CLEANING PROCEDURE OF THE SYSTEM AND R.O. MEMBRANE ELEMENT.

6. Storage & Cleaning Procedure

SHORT TERM SHUT DOWN

1. Close the seawater inlet valve 1.
2. Position the feed source directional control valve 3 to the rinse position (should connect feed pump inlet with cleaning tank).
3. Position the brine discharge directional control valve 18 to the normal operation position (from the back pressure regulator valve 17 to the brine discharge connection 22).
4. Open the back pressure regulator 17 fully.
5. Fill the cleaning tank 26 full with water from hydrophore.
6. Place the feed pump switch in the “AUTO” position.

7. Start the system by pressing the “START” switch.
8. After the rinse tank is empty or after sufficient rinse water has entered the system, stop the rinse cycle by pressing the system “STOP” switch.
9. Position the feed source directional control valve 7 to the normal operation position.

LONG TERM SHUT DOWN

1. Close the seawater inlet valve 1.
2. Position the feed source directional control valve 3 to the rinse position (should connect feed pump inlet with cleaning tank).
3. Position the brine discharge directional control valve 18 to the normal operation position (from the back pressure regulator valve 17 to the brine discharge connection 22).
4. Open the back pressure regulator 43 fully (100% open).
5. Fill the cleaning tank 26 full with water from hydrophore.
6. Place the feed pump switch in the “AUTO” position.
7. Start the system by pressing the “START” switch.
8. After the rinse tank is empty or after sufficient rinse water has entered the system, stop the rinse cycle by pressing the “STOP” switch.
9. Note. The System has now been rinsed with freshwater and is ready for storage chemical solution closed loop circulation as follows.

10. Position the brine discharge directional control valve 18 to the cleaning storage tank return.
11. Fill the cleaning tank with freshwater, add chemicals to the water by opening valve from chemical tank.
12. Start the system by pressing the “START” switch.
13. The system is now recirculating storage chemical solution.
14. Stop the system by pressing the “STOP” switch.
15. Position the brine discharge directional control valve 18 to the normal operation position (from the back pressure regulator valve 17 to the brine discharge connection 22).
16. Start the System by pressing the “START” switch.
17. Continue to operate the system until all of the storage solution has been discharged from the cleaning tank.
18. Just as the storage cleaning tank will be empty, stop the system by pressing “STOP” switch.

7. Filter's cleaning procedure

1. If the System is running it is necessary to:
 - a. Release the operating pressure in the system by turning the back pressure regulator fully open (100% open).
 - b. Stop the system by pressing the "STOP" switch.
2. Close the seawater inlet valve.
3. Press the "Clean" button located under the respective filter.

S-TYPE SEPARATION SYSTEM

1. System Overview

The **Separation Unit** is designed for cleaning fuel and lube oils of diesel engines, and for cleaning fuel and oil of gas turbine engines, in marine and power plants applications.

Heated oil is fed through the separator to clean the oil from solid particles and water.

The basic separator unit comprises:

- A separator,
- Ancillary equipment including control cabinet,
- Optional equipment such as sludge removal kit, butterfly valve, junction box for free positioning of the control cabinet.

The unit can be complemented with optional equipment such as feed pump, heating system and flow regulation, in the form of a single or double module.

Cleaned oil leaves the separator through the oil outlet while separated water and sludge accumulate at the periphery of the rotating separator bowl.

The control unit supervises the entire operation of the separation system, performing monitoring, control and alarm functions.

The process adapts automatically to changes in conditions, such as increased water content in the unprocessed oil.

2. Oil flow (fig. 1)

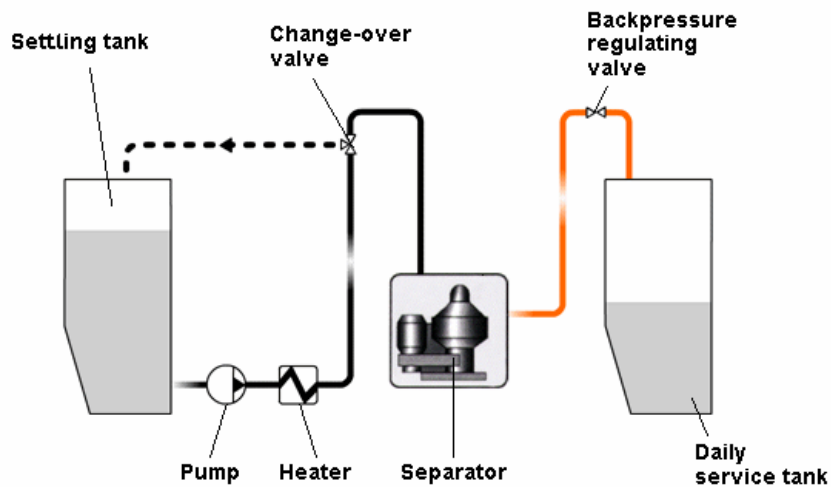

Fig. 1. Oil flow.

The unprocessed oil is fed through a **heater** by a **feed pump**, operating at a constant flow.

A change-over valve directs the oil to the **separator**. The cleaned oil is pumped from the separator to either the daily **service tank** (fuel oil), or back to the **engine** (lube oil).

During separator start and stop procedures and during alarm conditions the oil is directed via a **return line** to the **engine sump** or **settling tank**.

3. System layout
(fig. 2)

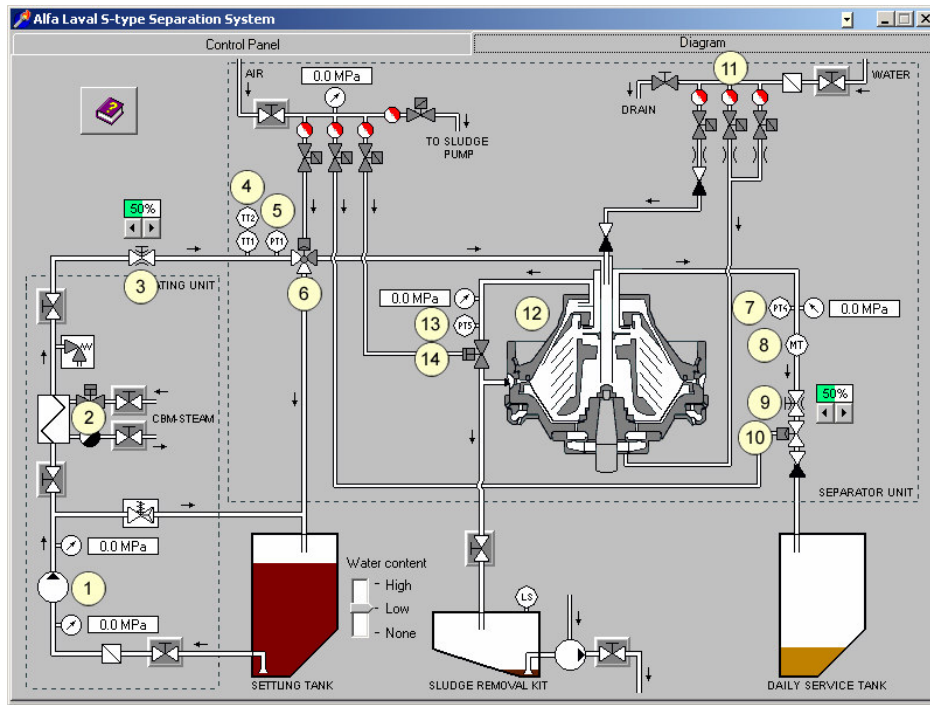

Fig. 2. Diagram

1. Feed pump
Feeds unprocessed oil to the separator.
2. Heater
Heats unprocessed oil to separation temperature.
3. Regulating valve
4. Temperature transmitter (TT1, TT2)
Measures the oil temperature and signals the control unit.
5. Pressure transmitter, oil (PT1)
Measures the pressure in the oil inlet, and signals the control unit.
6. Pneumatically controlled change - over valve (V1)
Directs the unprocessed oil to the separator, or back to the settling tank (recirculation - fuel oil only).
7. Pressure transmitter, oil (PT4)
Measures the pressure in the oil outlet, and signals the control unit.
8. Water transducer (MT4)
Measures change in water content in the cleaned oil, and signals the control unit.

9. Regulating valve (RV4)
Regulates the back-pressure in the clean oil outlet.
10. Pneumatically controlled shut-off valve (V4)
Closes the clean oil outlet.
11. Solenoid valve block, water
Distributes separator opening / closing water and conditioning water.
12. Separator
13. Pressure transmitter, water (PT5)
Measures the pressure in the water drain outlet and signals the control unit.
14. Drain valve (V5)
Opens when water is drained from the separator.

Graphic symbols used on the installation diagram are described in legend – fig. 3

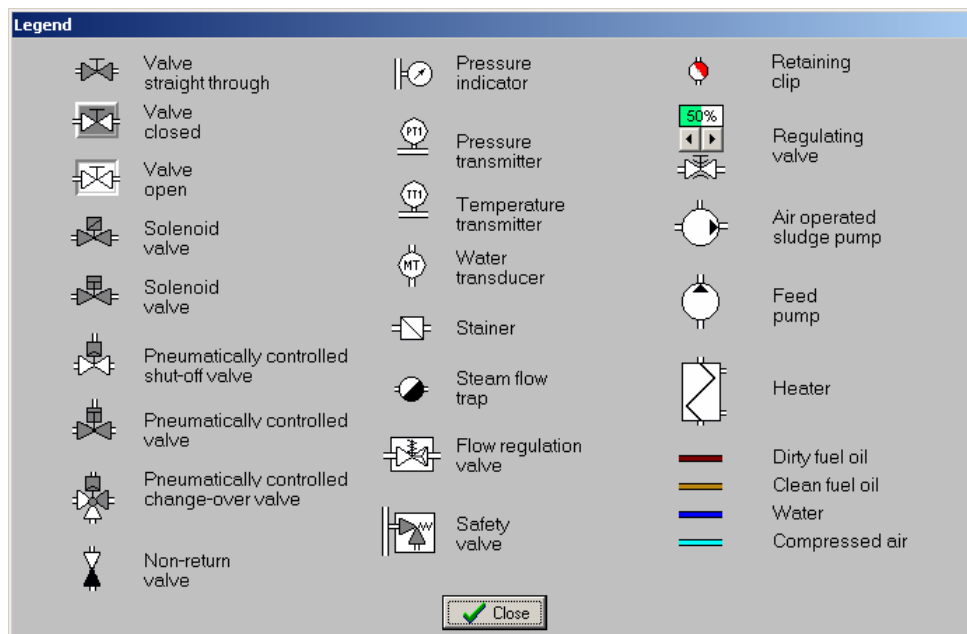

Fig. 3. Legend

4. Control panel description
(fig. 4)

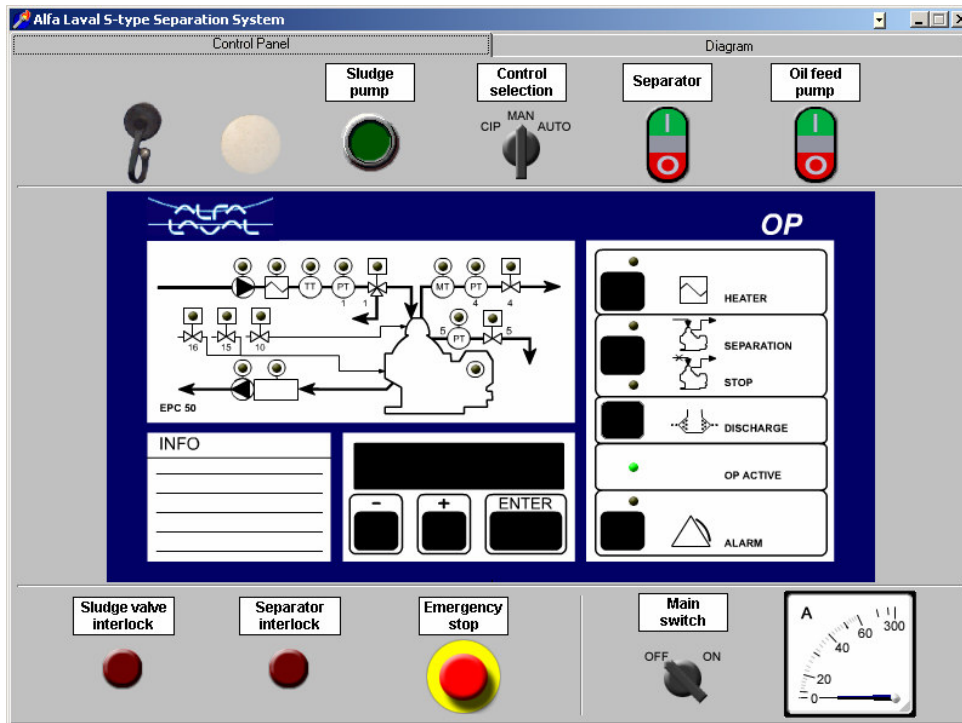

Fig. 4. Control Panel

Control panel consists of:

- “Oil feed pump” switch (on / off),
- “Separator” switch (on / off),
- “Control selection” switch (CIP / MAN / AUTO),
- Push-button „Sludge pump”
- “Main switch” switch (on / off),
- Push-button ”Emergency stop”,
- Alarm lamps:
 - “Sludge valve interlock”
 - “Separator interlock”
- Current gauge,
- Push-button „Heater”,
- Push-button „Separation / Stop”,
- Push-button „Discharge”,
- Push-button „Alarm”,

5. Process Principles

1. During the separation process, sludge and water accumulate at the periphery of the separator bowl.
2. Sludge and water are discharged at preset time intervals. During discharge, the oil inlet is closed. Excessive water can also be drained from the separator bowl between discharges.
3. The cleaned oil leaving the separator is tested for traces of water. Any increase in water is detected by the water transducer.
4. The signal from the water transducer is continuously transmitted to the control unit, in which a reference value is stored. The control unit compares the transducer signal with the reference value. A significant deviation from the reference value will cause draining of water.

6. Process Cycle Start

First the oil pump, separator and heater are started.

The temperature transmitter (TT) and the speed transmitter (ST) signal the EPC-50 control unit continuously. When the correct separator speed and the correct temperature are reached, a sludge discharge is carried out to ensure the bowl is empty. The control unit then starts the process cycle.

- a) The change-over valve directs the oil to the recirculation line. Conditioning water is added to the separator bowl until the pressure sensor in the oil outlet senses pressure and signals the control unit.
- b) The control unit registers the time taken for water addition. This water flow reference value is later used to calculate the correct amount of conditioning water and displacement water to be added.
- c) The separator discharges.

- d) Using the flow rate calculated in accordance with point 2 above, the control unit signals solenoid valve to open so that the correct amount of conditioning water is added to the separator bowl.
- e) The change-over valve opens so that oil is directed to the separator bowl. When pressure in the oil outlet is sensed, the pressure sensor (PT) signals the control unit. The control unit calculates and stores the time taken to add oil to the bowl.

The cleaning process is now running.

Unprocessed oil is fed to the separator, and clean oil is pumped from the separator.

7. Discharge

The separator discharges after a preset time has elapsed.

The following sequence takes place:

1. The change-over valve switches to oil recirculation.
2. Using the flow rate calculated in accordance with point 2 under Process Cycle Start, the control unit signals the solenoid valve to open so that displacement water is added to push the oil towards the disc stack.
3. After the calculated time for displacement water addition has elapsed, the separator discharges.
4. Conditioning water is then added, a new separation cycle begins.
5. After every discharge the **leak test** is carried out. Paring disk is pumping oil against closed pneumatically controlled shut off valve (V4). Control system does not expect any oil pressure drop.

8. Increased Water Content

If the water transducer senses increased water content in the oil, the following takes place:

1. The water drain valve opens for a number of seconds.

2. The water drain valve closes again, and the transducer signal is evaluated.
3. If there is still an increase in water content, the drain valve opens again. If the water content is still high after the drain valve has opened five times, a discharge is initiated.
4. If the water content has decreased, the separation cycle returns to normal.

9. Manual Operation

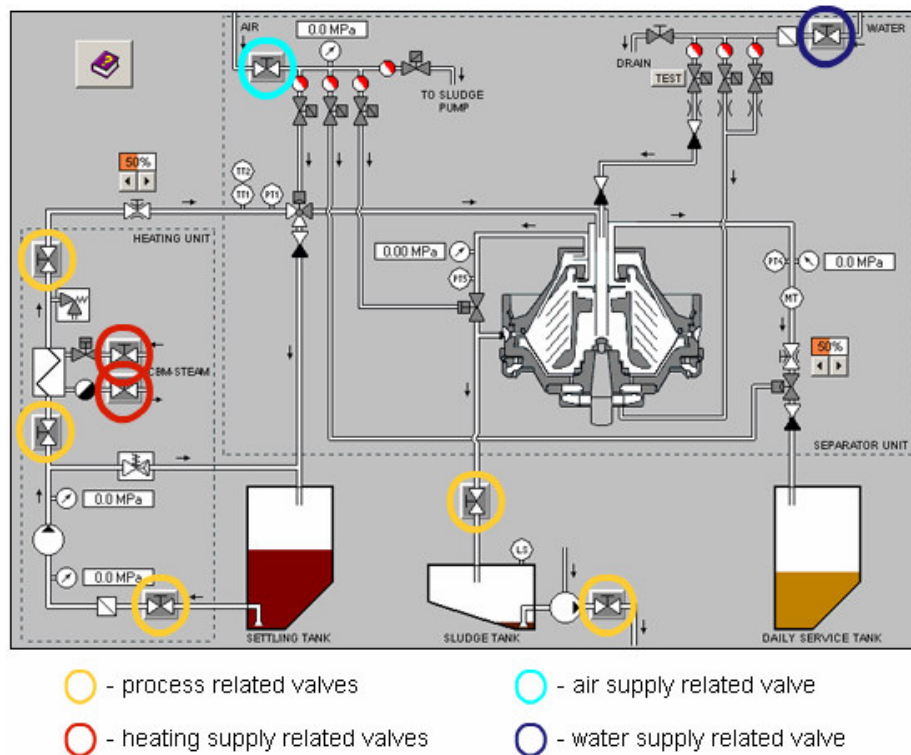

Fig. 4. Valves

1. Before start up make sure that the air supply related valve before the Air Valve Block is open (fig.4). Use the pressure gauge to check that the air supply is correct (5 -7 Bar).
2. Make sure that the water supply related valve before the Water Valve Block is open (fig.4).

3. Make sure that all **process related valves** are open. Open also **heating media supply valves** (fig.4).
4. Switch on the **power supplies**.
Make sure the **mode selection switch** is in the 'MANUAL' position.
5. Start the oil **feed pump** from the pump starter.
The oil flow can be read on the display (parameter In 32).
If applicable, set the desire flow using regulating valve RV4.
6. If necessary, vent **air** from the heater through the relief valve (if applicable).
Switch on the **heater** from the operator panel (if applicable).
7. Press the '**SEPARATION**' button to activate the ECP-50.
8. Before the separator can be started, a number of **questions** which have to be answered scroll across the display:
 - **"Has the bowl been dismantled? + = YES, - = NO"**
If the bowl has been dismantled press the "+" button. If no work has been carried out on the bowl, press the "-" button. The start sequence begins and the text "Start Separator" appears on the display. Calibration of the system is not carried out.
 - **"Assembled according to manual? + = YES, - = NO"**
If the bowl has been dismantled and assembled according to the instructions in the Service Manual, press the "+" button.
 - **"Bowl cleaned? + = YES, - = NO"**
If the bowl has been cleaned press the "+" button.

An automatic calibration of the system is carried out. See display.
9. Push the **separator start button**.
10. Listen and observe.

Vibration may occur during start up, when passing critical speeds. This is normal and should pass without danger.

If **vibration** increases, or continues at full speed, press the **emergency stop** button and stand clear until the vibration stops. The separator, feed pump and heater are stopped when the emergency stop button is pushed.

Once the zero speed signal has been received, the alarm reset button can be pushed. The message 'Switch power on/off' will be displayed. This refers to the EPC 50 power inside the control cabinet.

The cause of vibration must be determined and corrected before starting again !

11. The **separator speed**, and the message "**Wait !**" are shown alternately on the display until the separator is at full speed. When the separator is at full speed, "**Standby**" is shown on the display.
12. Check the **oil feed temperature** by pressing the "+" button until "**TT1**" is shown on the display.
13. Wait until the **oil feed temperature** is correct:
 - Heavy fuel mode 98°C
 - Lube oil mode 95°C (trunk engines), or 90°C (cross-head engines)
 - Diesel oil mode 40°C
14. When the separator has reached the correct **speed**, and the oil is at the correct **temperature**, "**Standby**" is shown on the display. Press the "**SEPARATION**" button on the operator panel to start the **separation process**.
15. Adjust the backpressure to the normal running value. Normal running backpressure is determined at commissioning.

10. During Operation

Observe the **operator panel information**:

- Heater operation LED lit (green)
- Separator system operation LED lit (green)
- Activated valve LED lit (green)

During normal operation, the ALCAP trigger signal is shown on the left side of the display, and the time left before next sludge discharge is shown on the right side.

Any alarm is indicated on the display.

More **operational information** may be read as required, by pressing the "+" button repeatedly.

0 57	The ALCAP trigger signal on the left of the display, and the time left before next sludge discharge on the right
TT1 96,0	Oil feed temperature
PT1 0,8	Oil pressure, oil inlet
PT4 2,0	Oil pressure, oil outlet
PT5 1,3	Pressure, water outlet
MT4 0	Water transducer value
Rpm 9000	Speed
Run time	Accumulated operating time in days and hours

To return to normal display, i.e. the trigger value and timer to next sludge discharge, continue pressing the "+" button.

11. Stop

1. **Stop the system** by pushing the "**SEPARATION**" button on the operator panel.

The yellow LED for separator stop sequence starts to flash.

A **sludge discharge** is initiated.

The stop sequence LED changes to steady yellow, and the green LED for separation system operation goes out, when the sludge discharge is completed.

2. "**Stop**" is displayed.

If the **heater** is controlled by the ECP 50, it is **switched off** automatically.

3. When the oil feed temperature has started to drop, the **oil feed pump** is **switched off** automatically.
4. The separator comes to a complete standstill after about 20 minutes "**Standst.**" is then displayed.

If the system is switched off for reasons other than high vibration, it is not necessary to wait for the separator to slow down before restarting the process.

COMBINED OIL FIRED AND EXHAUST GAS BOILER

1. Introduction

The educational program COMBINED OIL FIRED AND EXHAUST GAS BOILER SIMULATOR is intended for teaching the basic principles of how to operate a typical combined boiler.

The program is based on the boiler type AQ-16 produced by **AALBORG Industries Corporation**.

The program consists of the following parts:

- Control Panel
- Steam – Feed Water System
- Fuel Oil System
- Steam Heating System

2. Description

2.1. Oil fired and exhaust gas boiler

- Combined vertical oil-fired (bare water tube) and exhaust gas (bare smoke tube) boiler
- Integrated silencer as option
- Made of standard components
- Tailor-made according to engine capacity

The oil-fired part of the AQ-16 is based on the bare tube design. It has a 100% water-cooled furnace without refractory.

The AQ-16 has adequate room for inspection and maintenance in the steam/water space. The two smoke sides can be water-washed or mechanically cleaned through the boiler uptakes. The AQ-16 has a low space/performance ratio.

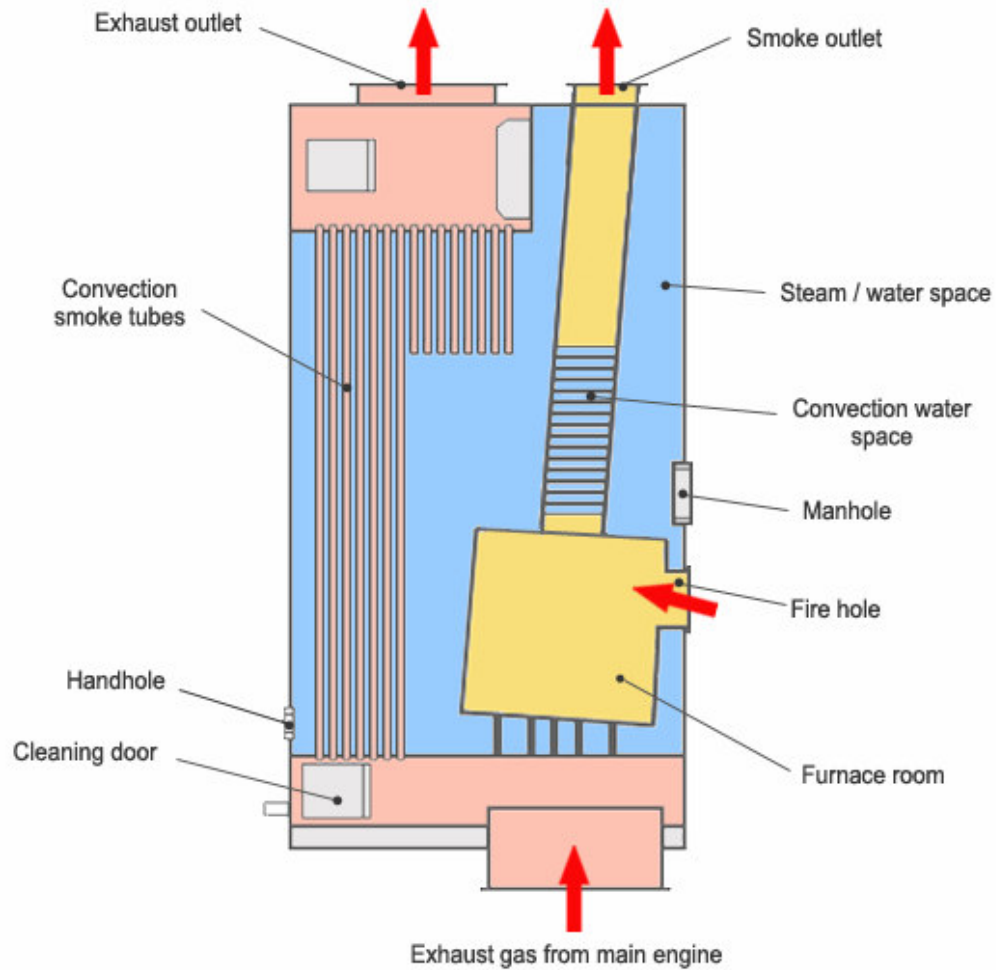

Fig.1 Boiler Cross-section

2.2. Steam-dumping equipment

The steam dump equipment is designed for dumping excess steam generated by the boiler plant from the steam system to an atmospheric dump condenser.

It is essential that the condenser is dimensioned to be able to absorb the amount of steam generated in the exhaust gas boiler or exhaust gas part of the combined boiler.

The equipment is working by measuring the steam pressure with a pressure transmitter (6). The transmitter sends an electrical signal to the process controller/local panel (5). In the control system the signal is compared with a pre-set adjustable value.

The steam pressure is then regulated when the control system sends an electrical signal to the I/P positioner (2).

It converts the signal and via the pneumatic actuator (3) controls the position of the steam dump valve (1).

The excess steam is directed to the atmospheric dump condenser.

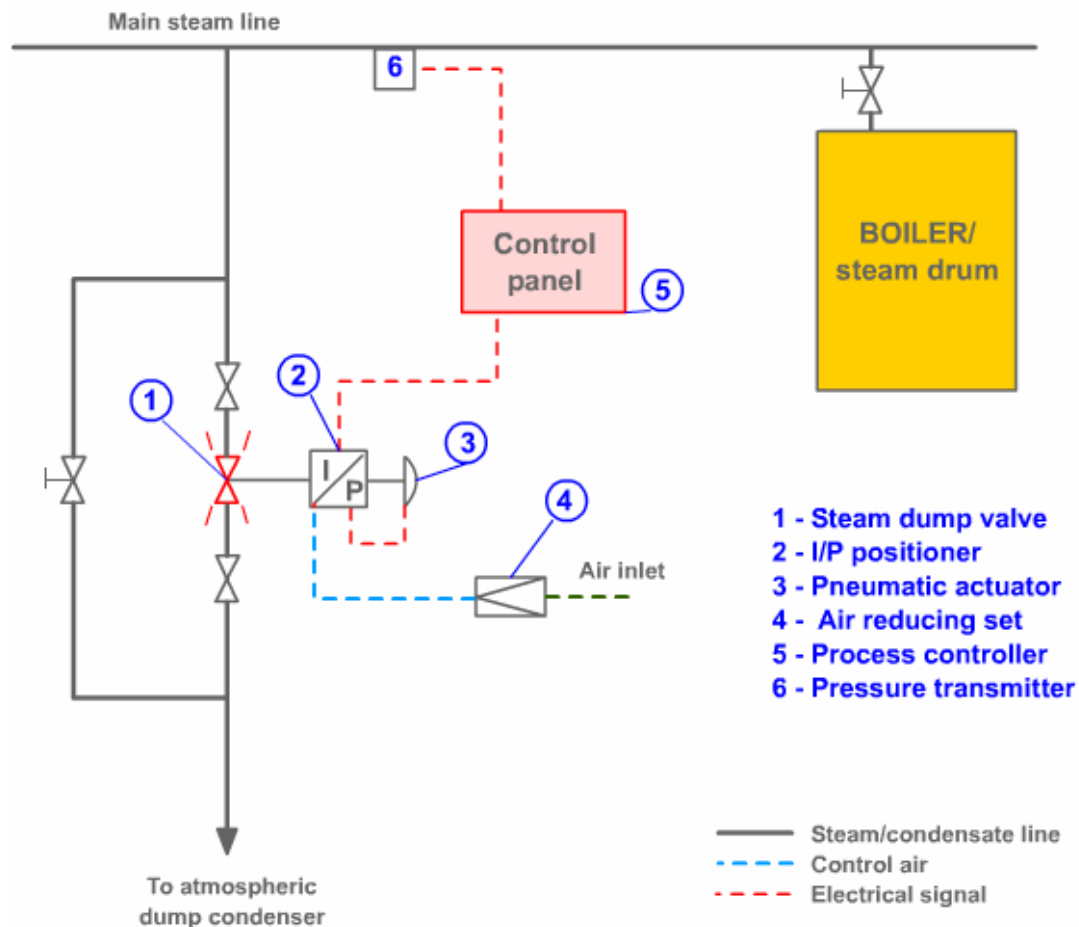

Fig. 2 Steam dumping equipment

2.3. Process controller, SIPART DR21 (Steam-dumping equipment)

The process controller is a programmable controller with digital data processing. Analogue signals are fed into the process controller and compared to the adjustable set point in the process controller. After the data are processed, an electric signal is fed to an adjustable unit which controls a media (water, air, fuel, steam etc.). A number of functions are filed in the programme memory of the controller. These functions are activated from the memory.

Operation and monitoring

The process controller is suitable for a wide range of applications. It can be used as K-controller or S-controller. K-controllers are for connection to pneumatic or hydraulic actuators with proportional gain. S-controllers can be programmed either as a three-position step controller for electric actuators or a two-step controller with two outputs for heating and cooling.

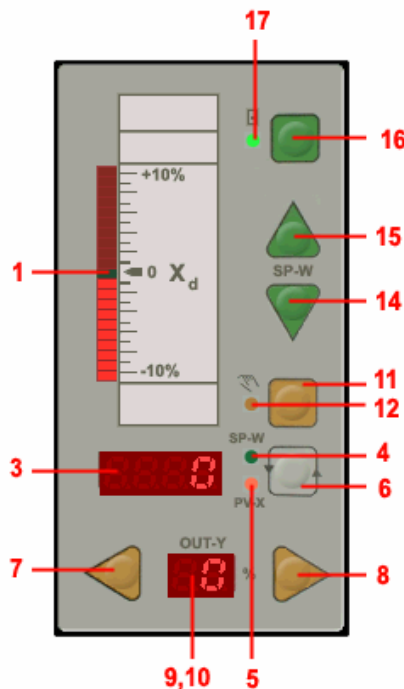

Fig 3. Process controller

Table 1.

Description of position numbers in Figure 3		
Display actual and set point values		
1	Indicator	Analogue indicator for actual value "x (pv)"

3	Indicator	“x/w” digital indicator. Other values can be displayed
4	LED	“w” signal lamp – lights up when w is displayed
5	LED	“x” signal lamp – lights up when x is displayed
6	Push button	Switch-over push button for w/s digital indicator. Push button to acknowledge flashing after power is restored or for accessing selection level.
<u>Modify manipulated values</u>		
7	Push button	Button to modify manipulated value – close (open)
8	Push button	Button to modify manipulated value – open (close)
9	Indicator	“y” digital indicator
10	LED	Signal lamp for “dy” digital outputs on S controller
11	Push button	Manual/automatic switch-over push button and “Enter” push button to move from selection level to configuration level
12	LED	Signal lamp – manual mode
<u>Modify set point value</u>		
14	Push button	Reduce – set point value push button
15	Push button	Increase – set point value push button
16	Push button	Switch-over button for “internal/external set point” or “Exit” button to return from configuration and selection levels to the process control level
17	LED	Signal lamp for “internal set point”

Operation in the process control level

Internal set point “w”

Internal set point “w” can be changed by the push buttons (14) and (15) if “w” is displayed (display 3), and the controller is in internal mode (LED 17).

Manipulated variable “y”

The manipulated variable “y” can be changed by the push buttons (7) and (8) if the controller is in manual mode (LED 12).

Internal and external set point

Push button (16) is used to toggle between internal and external set point. LED (17) illuminates when the internal set point is being used.

Manual and automatic mode

The yellow push button (11) toggles between manual and automatic mode. The active mode is signaled by the LED (12).

Accessing the levels

Configuration and parameterisation are performed from the front panel of the process controller. The function of the front panel is first changed from the process control level to the selection level. From this level the configuration level can be selected.

On-line parameters (onPa)

Parameters that determine how the process runs and can be modified during unrestricted controller operation (on-line).

Accessing the onPa list

- Press button (6) for about 6 sec. Release the button, and “onPA” (selection level) is displayed.
- Press button (11) once (configuration level).

Selecting and modifying parameters

- Use buttons (7) or (8) to select parameter names from y digital indicator (9).
- Use buttons (14) or (15) to modify the parameter value in the “w/x” digital indicator(3).
- Repeat these steps until all desired parameters are set.

Exit to process control level

- Press button (16) twice (selection level and process control level)

Off-line parameters (oFPa)

Parameters determining basic functions such as display elements, limit values, safety values, etc.

Accessing the oFPa list

- Press button (6) for about 6 sec. Release the button, and “onPA” (selection level) is displayed.
- Press button (15) several times until “oFPa” is displayed.
- Press button (11) once (configuration level). The controller is now blocked, and the last value of “y” is retained.

Selecting and modifying parameters

- Use buttons (7) or (8) to select parameter names from “y” digital indicator (9).
- Use buttons (14) or (15) to modify the parameter value in the “w/x” digital indicator(3).
- Repeat these steps until all desired parameters are set.

Exit to process control level

- Press button (16) twice (selection level and process control level)

Configuring switches (StrS)

Switches that define how the instrument is configured.

Accessing the StrS list

- Press button (6) for about 6 sec. Release the button, and “onPA” (selection level) is displayed.
- Press button (15) several times until “StrS” is displayed.
- Press button (11) once (configuration level). The controller is now blocked, and the last value of “y” is retained.

Selecting and modifying configuring switches

- Use buttons (7) or (8) to select parameter names from “y” digital indicator (9).
- Use buttons (14) or (15) to modify the parameter value in the “w/x” digital indicator (3).
- Repeat these steps until all desired parameters are set.

Exit to process control level

- Press button (16) twice (selection level and process control level)

2.4. Feed and boiler water

Important: These recommended feed and boiler water characteristics are only valid for boilers with a working pressure below 2 MPa.

Boiler and feed water should be chemically treated in order to avoid corrosion and scaling in the boiler.

In most vessels make-up / feed water is distilled by an evaporator, and the distillate is generally very good make-up water. Other methods to produce make-up water, e. g. reverse osmosis plants or ion exchange plants, are also possible good distillate producers. The important thing is that the distillate used should be clean and without foreign salt contamination.

In practice most distillate used contains minor parts of various salt combinations, which can be chemically treated away.

Further, the distillate may contain dissolved gases like for example oxygen (O₂) and carbon dioxide (CO₂), which may lead to corrosion in the boiler, steam and condensate system.

Note : It is of great importance that the feed and boiler water are chemically treated in order to avoid corrosion resulting from the above mentioned factors.

It is recommended that the operator contacts an established water treatment company and gets assistance to have a suitable water treatment system put into operation from the very beginning of the service of the boiler.

2.5. Oil Burner type MS 7 Z

The burner type is a pressure atomizing burner with two nozzles for two-stage operation provided for diesel oil.

The burner housing is mounted on the boiler front on side hinges so that the burner can be swung to either side depending on conditions such as position of fittings, pipes or bulkhead.

A cover for inspection and cleaning of air duct is fitted on top of the house. A cover is fitted on the left side behind which the electric terminals and ignition transformer are located. Further, a switch blocking the start sequence, if the burner is swung out, is fitted on the front edge of the burner housing.

Burner equipment

Fan motor is fitted on the side of the housing and is connected to the fan wheel directly and the oil pump via a coupling.

The air is sucked through an intake, in which two dampers are provided.

Oil pump is a gear-wheel pump provided for a pressure up to 3 MPa. The pump has a built-in pressure regulator and filter.

Oil pipe to burner is always made of flexible hoses from gas/air separator in the oil ring main circulation line to the pump (to make it possible to swing out the burner on its hinges)

Burner body is mounted with two oil nozzles.

Nozzles are of type Monarch PLHO 60⁰ or Steinen. Nozzle 1 delivers about 2/3 of the total oil quantity.

Servo motor or damper-motor sets the air quantity in proportion to the oil quantity fired. The adjustment is made by means of a motor driven cam-shaft on which four cam switches are placed activating some switches. These switches are marked I, II, III and IV. They are counted from front and backwards to motor and have the following functions:

I — determines the opening time for solenoid valve for “NOZZLE 2”. This is to open after a movement of 2/3 from partial load position to full load position.

II — determines partial load position (“NOZZLE 1”).

III — determines full load position (“NOZZLE 1+2”).

IV — is set so that the inlet damper is fully closed, when the burner is not in operation, in order to reduce the natural draft through the boiler.

Adjustment of final position is made after measuring of CO% and soot spot of smoke gas.

Solenoid valves:

The type NORMALLY OPEN (NO) for “NOZZLE 1”.

The type NORMALLY CLOSED (NC) for “NOZZLE 2”.

The safety oil-off valve.

The purpose of the last mentioned valve is to close oil flow to the nozzle solenoids, when the burner is stopped.

Gas/air separator enables to leave out gas/air pockets from the oil. It is mounted in oil ring circulation pipe.

Burner management

LOK 16 is a control box for the burner. It is operated by a motor driving camshaft that activates some switches in a rated order. These switches control various components as servomotor, solenoid valves, burner motor, ignitions and flame control.

Flame control device detects the flame by means of a photo-cell named RAR 7 inserted in the left side of the burner housing.

REMEMBER that the photo-cell is polarized.

Air guide vane is placed in front of the nozzles and with the purpose of mixing air and oil mist to a suitable mixture. Further, the shape and length of the flame is determined by the mutual relationship among nozzles, diffuser disk and combustion head.

Safety device

In order to prevent unburnt oil to spray into the furnace, the oil burner is provided with a photo unit. If the flame is not established after one start procedure, the oil burner is switched off automatically, and the signal lamp “Flame failure” lights red. New start can only be made after manual reset.

If the burner does not succeed in establishing the flame, a switch-off takes place again, and new start can only be made after a manual reset.

If the burner swings out the oil burner switches off and a new start can only be made after a manual reset.

The function of the burner is controlled by the burner control situated in the control panel.

Emergency operation

If the program control or the photo unit fails, the oil burner has to be started manually.

Important

At emergency operation of the boiler/oil burner, supervision is required by a member of the crew, because some of the safety devices are out of operation.

3. Simulator

The program consists of the following parts:

- Control Panel
- Steam – Feed Water System
- Fuel Oil System
- Steam Heating System

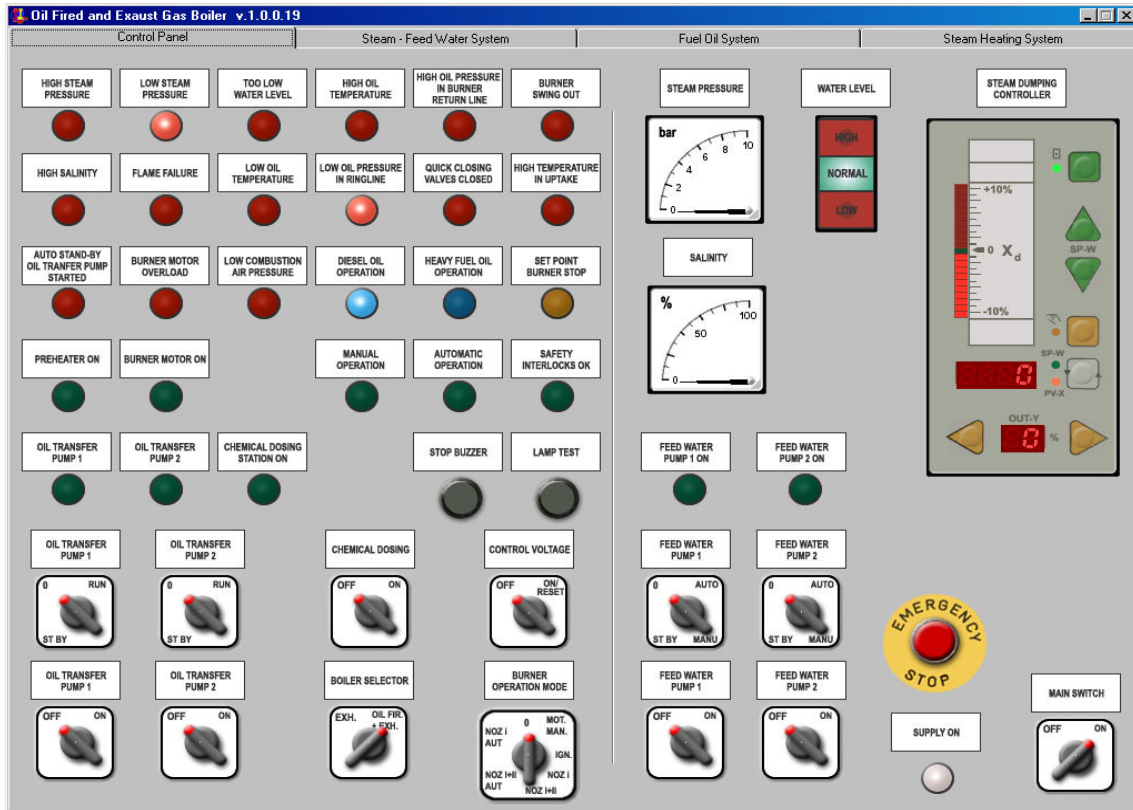

Fig. 4 Control Panel

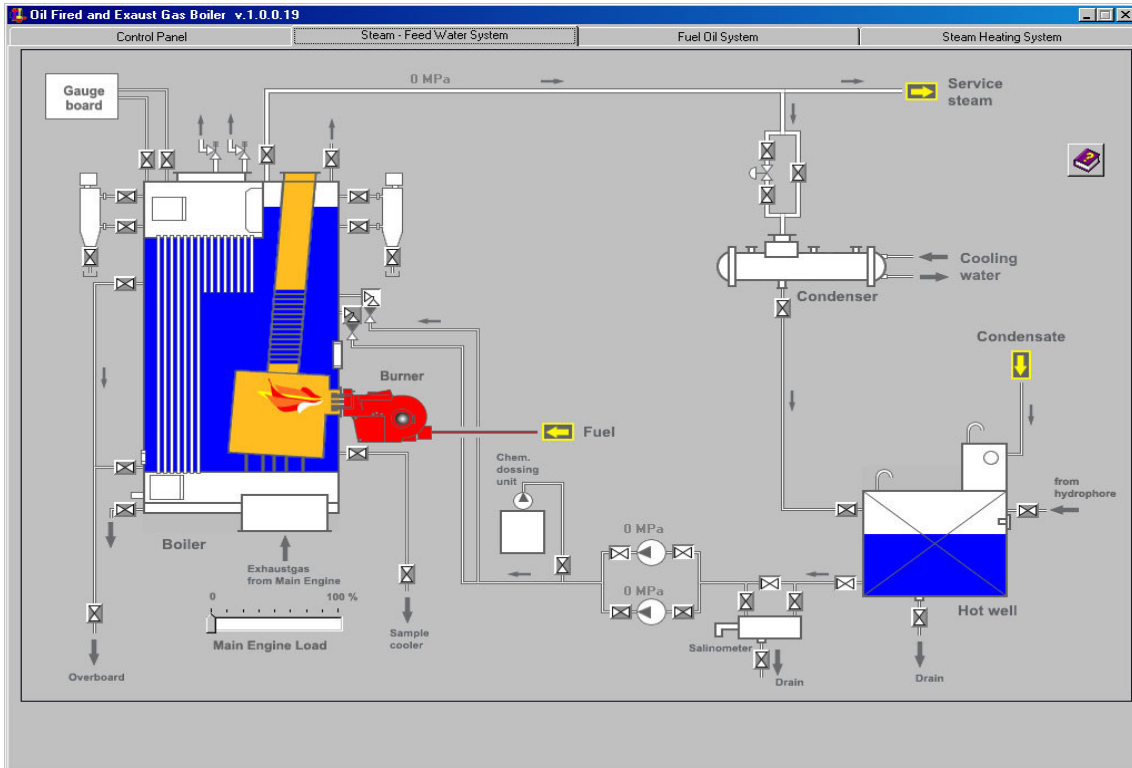

Fig. 5 Steam – Feed Water System

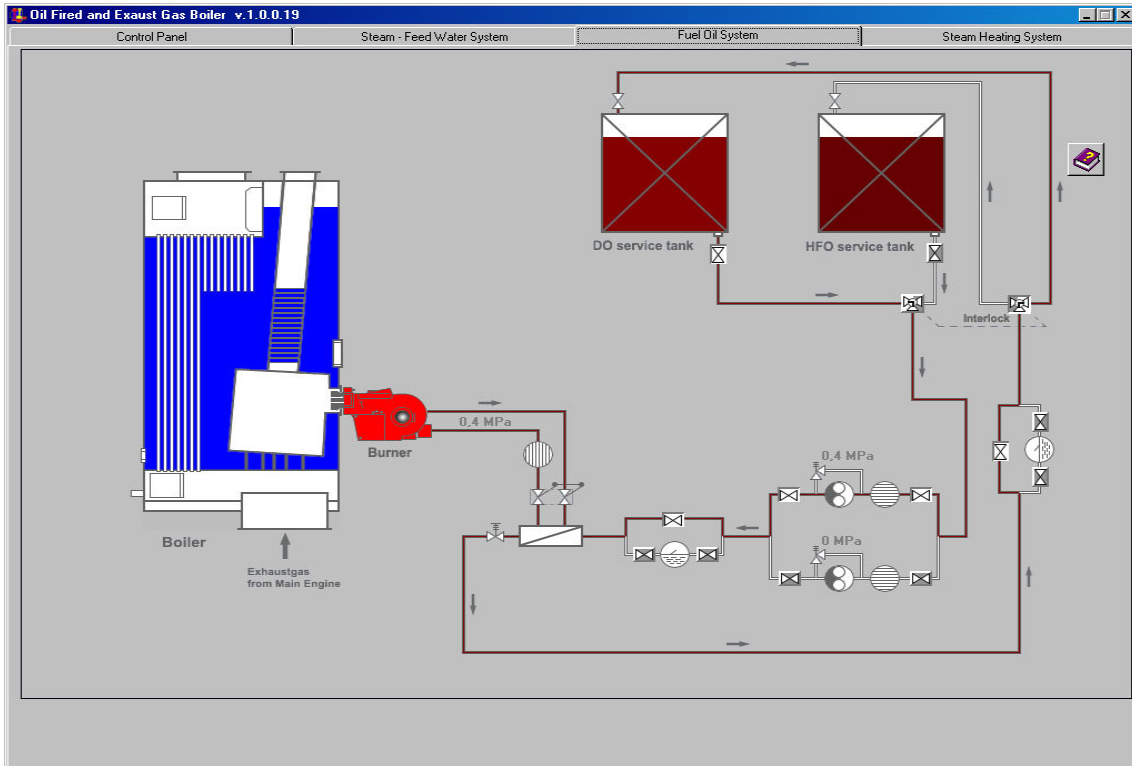

Fig. 6 Fuel Oil System

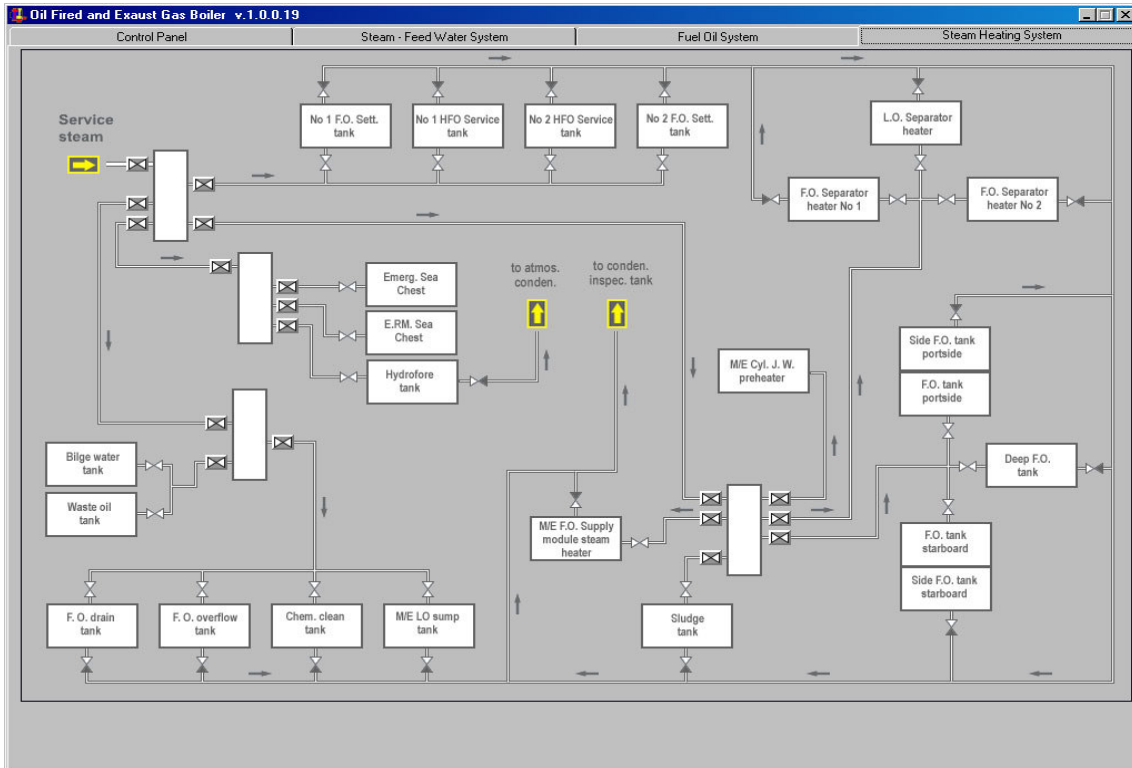

Fig. 7 Steam Heating System

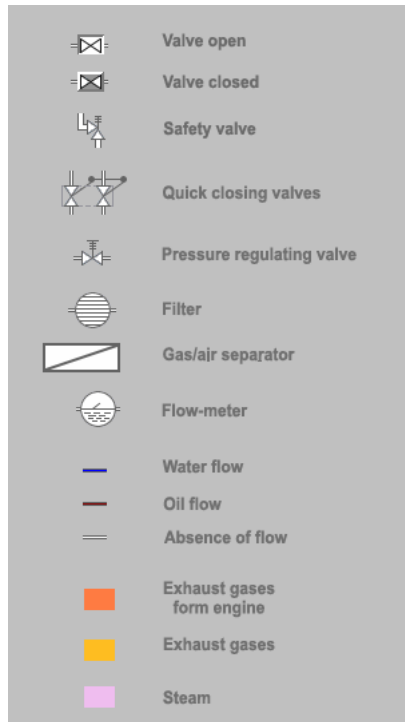

Fig. 8 Legend

4. Operating procedures

4.1. Start on diesel oil

Usually the burner is used on diesel oil only when the boiler/steamer system is cold and has to be heated up.

1. Check that D.O. is available in the D.O. tank.
2. Switch on “**Main switch**”.
3. Reset the switch for “**Control voltage**”.
4. Change over to “**Diesel oil position**”.

5. The alarms for “**Too low water level**”, “**Low steam pressure**” and “**Low oil pressure**” are on.
6. Open the air valve on top of the boiler.
7. Start the feed water pump.
8. Start the oil transfer pump and check the oil pressure.
9. If it is necessary to adjust the oil pressure, it is done by the pressure regulating valve.
10. When the water level is normal, reset the alarms at the reset switch. Only the “**Steam pressure low**” alarm remains on.
11. Check that the quick closing valves between the gas/air separator and burner are open.
12. Switch the burner on “**Nozzle 1 Aut.**” and the burner motor starts.
13. The diesel oil is now circulating through the burner and the servomotor takes the pre-purge position.
14. After the pre-purge time ignition process starts. The ignition takes place and after 2.5 sec. the solenoid valve for “Nozzle 1” is actuated, closing the recirculation and the diesel oil is sprayed into the furnace.
15. When the boiler is cold and without pressure, the burner must only run in minimum position “**Nozzle 1**”. When the steam pressure is higher than the low steam pressure, the burner can change over to “**Nozzle 1 + 2**”.
16. When the steam pressure reaches approx. **0.1 MPa**, the air valve of the boiler can be closed as there is no longer any air in the boiler.
17. When the steam pressure is normal and the steam plant outside the boiler is ready, the **main steam valve** always has to be opened very slowly to avoid water and steam shock.

When the steam pressure is normal and the steam plant outside the boiler is ready, the main steam valve always has to be opened very slowly to avoid water and steam shock.

4.2. Change over to heavy fuel oil

The set point of the preheater temperature appears on the temperature/viscosity diagram. The adjusting thermostat is placed behind the cover of the preheater.

1. Check that HFO is available in the HFO tank.
2. Switch off the burner.
3. Open the oil valves from the heavy fuel oil tank.
4. Change the valve position from diesel oil to heavy fuel oil.
5. Check the oil pressure in ring line and adjust it, if necessary.
6. Switch the burner on “**Nozzle 1 Aut.**” and the burner motor starts.

The burner motor starts and the electric oil preheater starts heating together with the oil filter, the solenoid valve, nozzle head and the oil pump.

After about 50 sec. the burner begins pre-purge time and after about 25 sec. the flame is established.

If the oil is very cold, the burner may cut out after about 50 sec.

Reset and try a new starting period and then the oil temperature should be high enough.

If the burner has been stopped on heavy fuel oil operation for a very long time and the oil ring line is filled with cold fuel oil, it is important that the burner is started again very carefully.

1. Switch on the power for the control panel, but with the burner in position “Off”.
2. Start the oil transfer pump.
3. Wait 30 sec. for heating up the oil filter, the solenoid valve, nozzle head and the oil pump.
4. Start the burner for 2 sec. and stop it again. If the pump has no difficulties in circulating the oil, then let the burner run.

If the boiler has been shut off for a long period, it is preferable to change over from heavy fuel oil to diesel oil, because it is the easiest way of starting the burner, when everything is cold.

4.3. Manual operating of burner

*The burner is running manual, the flame safety device is out of function.
The flame has to be supervised manually all the time.*

1. Set the switch in pos. "Manual motor".
The oil burner starts for manual purge.
Purge time takes appr. 1 minute.
2. Set the switch in pos. "Manual ignition".
The electrodes ignite after appr. 30 sec.
3. Set the switch in pos. "Nozzle 1 Man.".
The flame is established.

Wait 30 sec. before ignition starts, to **secure a minimum purge time.** Before the end of the 30 sec. time, the solenoid valve can not switch on, even if the manual switch is set from the "off" position to the "Nozzle 1 Man." position.
If the boiler load is high, the burner switch is set on "Nozzle 1 + Nozzle 2 Man.".

The burner is running manually, the flame safety device is out of function !

The flame has to be supervised manually all the time !!!

When the burner runs manually the functions "**Too low water level**", "**Burner swing out**", "**High steam pressure**", "**High oil pressure in burner return line**" and "**Overload of burner motor**" are activated.

When the burner runs manually the functions "**Flame Detector**", "**Start/stop nozzle 1**" and "**Start/stop nozzle 2**" are not activated.

REMOTE CONTROL SYSTEM FOR SULZER RTA ENGINES

1. General description

The educational program **REMOTE CONTROL SYSTEM FOR SULZER RTA ENGINES** is intended for teaching the basic principles of how to operate a typical remote control system, that is being presently used on ships. This simulator is based on the **AUTOCHIEF-4** remote control system, produced by NORCONTROL AUTOMATION A.S., the execution of the operations is performed through engine control system (diesel engine interface) **DENIS -1**.

The program consists of the following parts:

- Engine Telegraph and Bridge Subtelegraph
- Engine Telegraph and Control Room Subtelegraph
- Engine Telegraph and Emergency Subtelegraph
- Control Room Unit Panel
- Engine Control System Diagram
- Air Station Diagram

After programme starting, the Control Room Unit Panel appears on the computer screen. The choice of the other panels is done by mouse clicking on the field of the appropriate panel (single mouse clicking of the left button).

2. Remote Control System AUTOCHIEF-4

Remote Control System AutoChief-4 is produced with utilization of microprocessor technology and it is a standard equipment of many engine rooms.

The system consists of:

- **ENGINE TELEGRAPH (MANUAL) CONTROL SYSTEM,**
- **AUTOMATIC (REMOTE) CONTROL SYSTEM,**
- **ORDER PRINTER UNIT,**
- **SAFETY UNIT,**

Units which are available in the simulator are marked with red line on the diagram (Fig. 1).

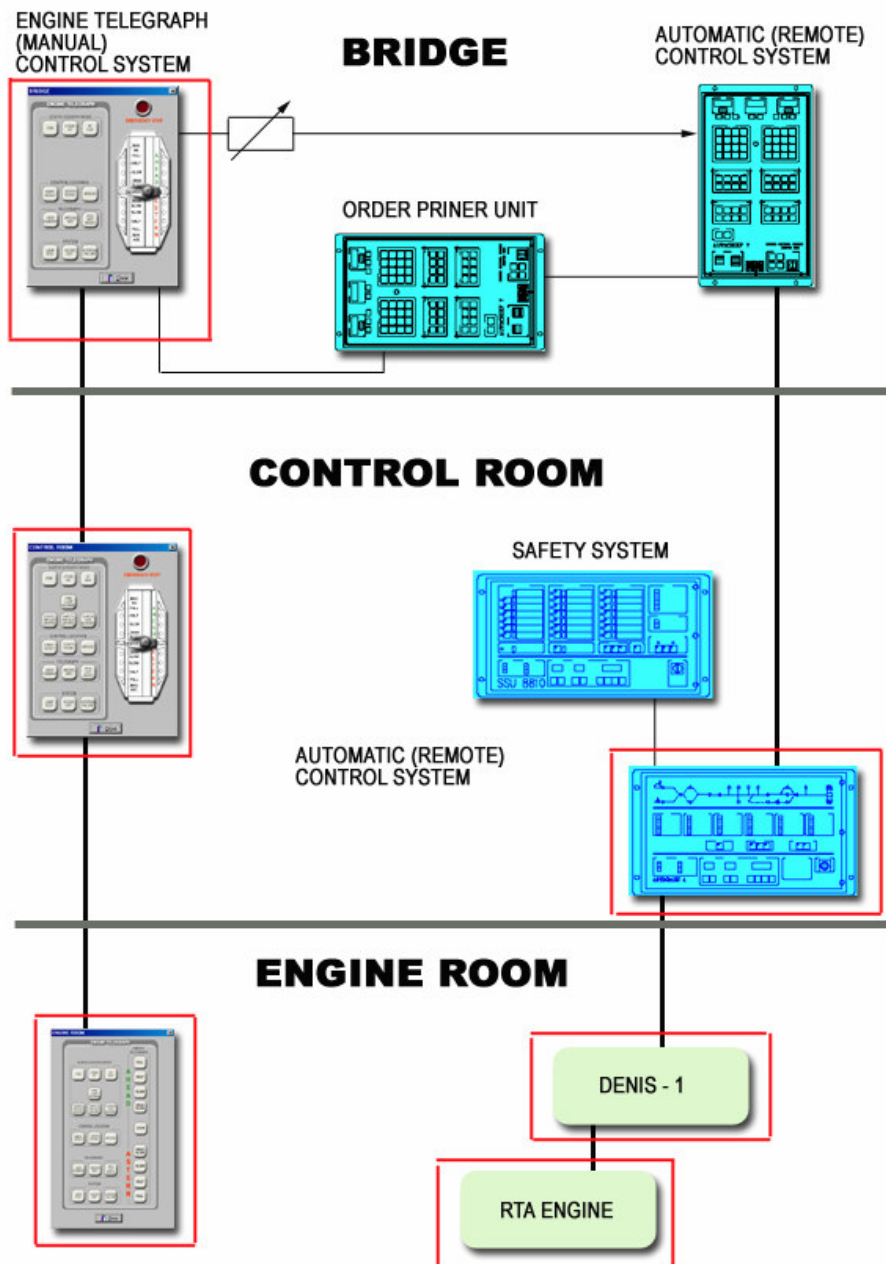

Fig. 1

2.1. Engine telegraph and subtelegraph.

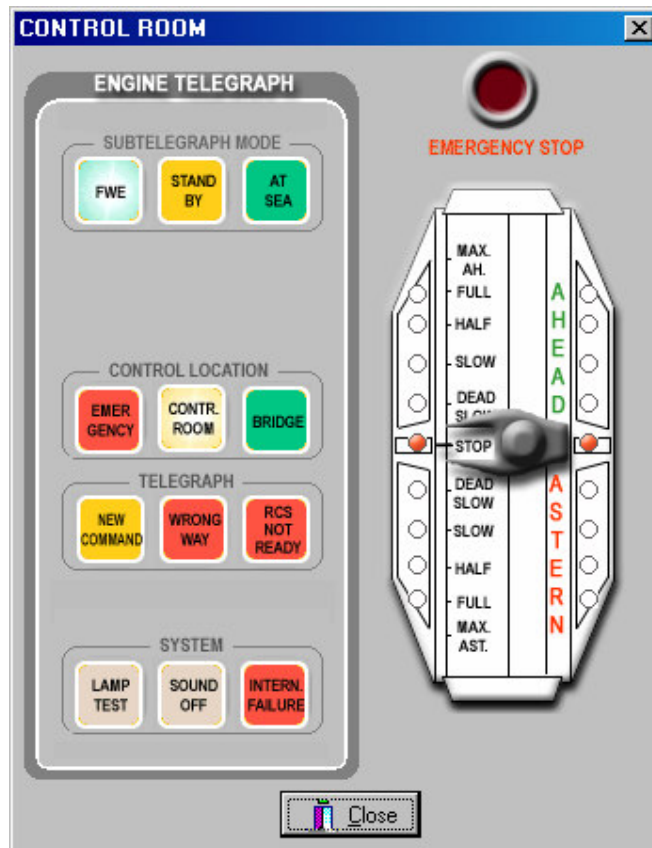

Fig. 2

Engine telegraphs constitute a very important link between the bridge, control room and local engine control for transfer of messages, such as:

- Finished with engine
- Stand by
- At sea
- Wrong way alarm
- Power failure alarm
- Remote control system status
- Interface to Order Printer
- Engine control location

Engine telegraphs are designed to control the engine and comprise an Engine Telegraph unit with telegraph handle and emergency stop switch at the following location:

- Bridge
- Control room

Engine Subtelegraph contains the following buttons:

- FWE (FINISHED WITH ENGINE)
- STAND BY
- AT SEA

Bridge buttons are used for giving information and the control room buttons for confirming the information .

- FWE LOOP ABNORMAL
- CONTROL AIR NOT VENTED
- SAFETY AIR NOT VENTED
- START VALVE NOT BLOCKED
- EMERGENCY
- CONTROL ROOM
- BRIDGE
- NEW COMMAND
- WRONG WAY
- RCS NOT READY
- LAMP TEST
- SOUND OFF
- INTERNAL FAILURE

Local engine control subtelegraph is integrated with digital engine telegraph. It consists of 9 highlighted buttons which are used for confirming orders from bridge. Orders from bridge are signaled by blinking lights.

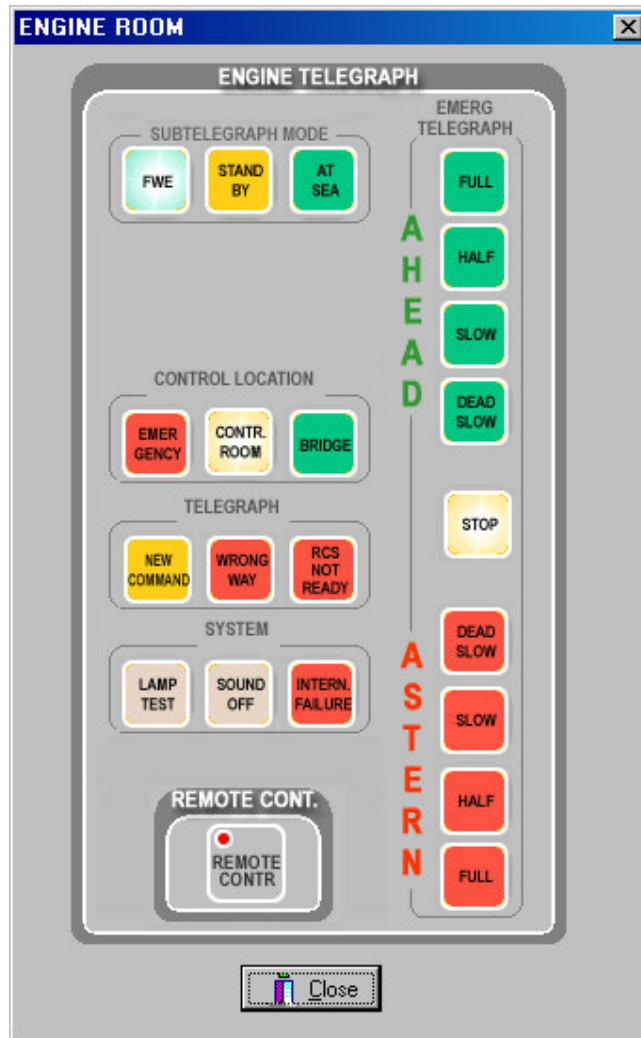

Fig. 3

2.2. Control Room Unit Panel

The AC-4 **control room unit**, consists of main electronic unit, containing a microprocessor that processes the I/O signals and is interfaced to the front panel, which is a display & control panel. The front panel enables the operator to carry out certain operations, and gives information about different status in the system. The front panel is also used for commissioning.

Simulator includes only the elements, which are directly connected with the steering process (there are no elements which are used for settings parameters of the systems).

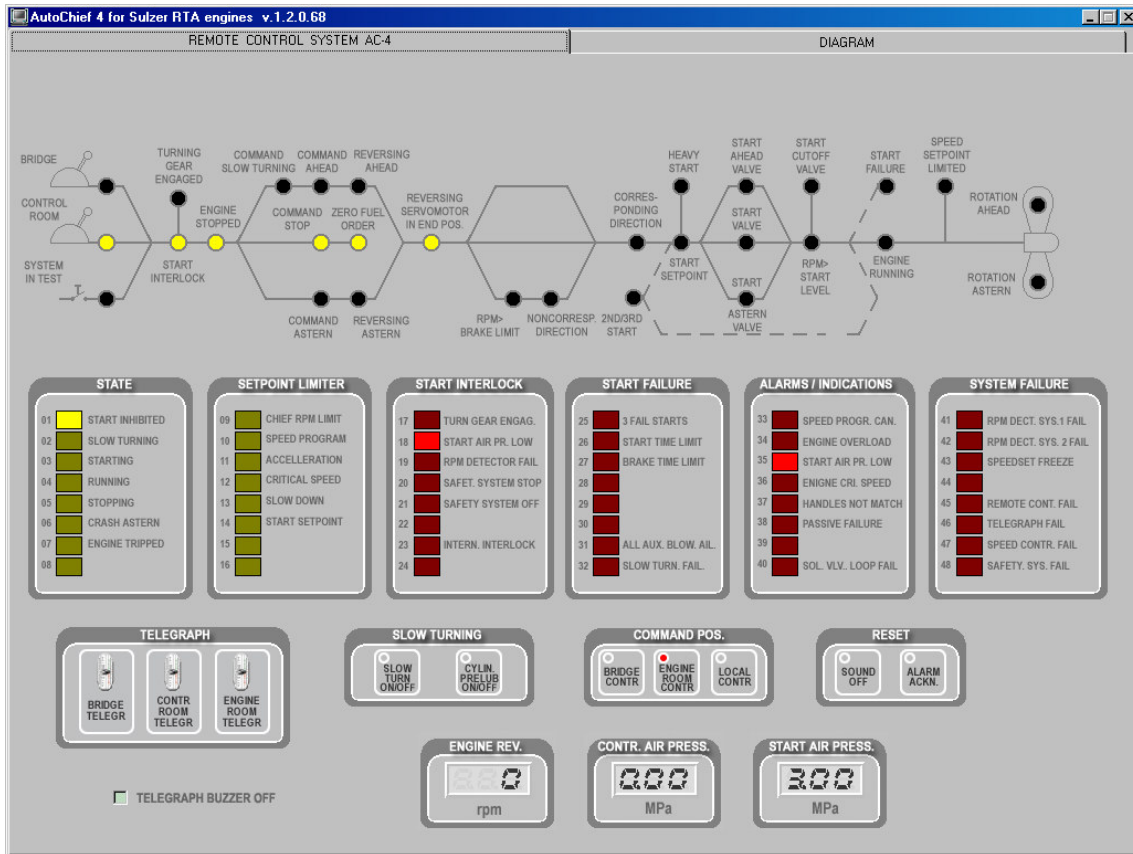

Fig. 4

2.2.1. Mimic diagram section

The AutoChief 4 control room unit has a mimic diagram on the top of the panel. The mimic diagram is provided to inform about the different sequences of the remote control system, and to give useful information to the user during operation of the main engine.

INDICATOR	DESCRIPTION
BRIDGE/ CONTROL ROOM/ SYSTEM IN TEST	The LED is lit on the respective control position.
TURNING GEAR ENGAGED	The LED is lit when the turning gear is engaged.
START INTERLOCK	The LED is lit when a start interlock is active, please see start interlock field section.
ENGINE STOPPED	When Bridge lever or Control Room lever is set to STOP and engine is at standstill this LED is lit.
COMMAND SLOW TURNING	Indicates that a slowturning sequence has been activated.
COMMAND AHEAD/ASTERN	Indicates that AHEAD or ASTERN command from the lever in control has been activated.
REVERSING AHEAD/ASTERN	Indicates that reversing ahead/astern valve is activated, during the start sequence and 60 sec. after it..
COMMAND STOP	Indicates that the lever in control is set to stop position.
ZERO FUEL ORDER	Indicates that zero fuel order is given to the governor. Fuel will not be released to ME.
REVERSING SERVOMOTOR IN END POSITION	Indicates that servo motor is in end position.
RPM > BRAKE LIMIT	Indicates ME rpm is above brake air limit. Air will not be supplied before this lamp turns off during crash astern/ahead.
NONCORRESP. DIRECTION	Indicates that ME is rotating in opposite direction of the

	position of the lever in control.
CORRESP. DIRECTION	Indicates that the lever in control and ME is running in corresponding direction.
START SETPOINT	ME is about to start and RPM command to Main Engine is limited by pre-programmed rpm limiters for Start or Heavy Start.
HEAVY START	Crash astern or repeated start sequence is activated. RPM command to Main Engine is limited by pre-programmed rpm limiters for Heavy Start.
START AHEAD/ASTERN VALVE	Indicates that ahead or astern start solenoid valve are energised.
START VALVE	Indicates that start solenoid valve is energised.
START CUTOFF VALVE	Indicates that start cutoff valve is energised.
RPM > START LEVEL	Indicates that ME RPM is above the preset start cutoff level.
START FAILURE	Indicates start failure. Detailed information is given by a red LED indicator in the Start Interlock/Failure section.
2ND/3RD FAILURE	The first start attempt has failed and 2nd or 3rd start attempt is initiated.
SPEED SETPOINT LIMITED	The ordered speed command is limited by a setpoint limiter. Detailed information is given by a yellow LED indicator under the setpoint limiter section.
AHEAD /ASTERN ROTATION	The propeller rotates according to the LED which is energised.

2.2.2. State section

The AutoChief 4 control room unit contains a section named “STATE”. This section contains 8 yellow light diode (LED) indicators, and informs the operator about the state of the system, and what sequence is executed.

INDICATOR	DESCRIPTION
(1) START INHIBITED	Start is inhibited because of a failure stated in the START INTERLOCK section..
(2) SLOW TURNING (option)	Push-button for slow turning is activated, and ME is performing a slow turning sequence.
(3) STARTING	Main Engine's starting / stopping sequence is activated.
(5) STOPPING	
(4) RUNNING	Engine is running either in Ahead or Astern direction.
(6) CRASH ASTERN	Crash astern is detected and sequence is activated.
(7) ENGINE TRIPPED	Engine has tripped because of shut down/overspeed action made by Safety System unit.

2.2.3. Setpoint limiter section

The AutoChief 4 control room unit contains a section named “SETPOINT LIMITER”. This section contains 8 yellow light diode (LED) indicators, and indicates that the engine speed is limited by a setpoint limiter, and that the actual engine speed is kept lower than the speed order from manoeuvring lever.

INDICATOR	DESCRIPTION
(9) CHIEF RPM LIMIT	Indicates that ME rpm command is limited by the chief rpm limit, manually set from this panel.
(10) SPEED PROGRAM	Indicates that ME rpm command is limited by the speed program.
(11) ACCELRA TION	Indicates that ME rpm command is limited by the acceleration limiter curve.
(12) CRITICAL SPEED SETPOINT	Rpm command from the lever in control is set within the critical rpm area. Setpoint is limited until the telegraph lever is moved from the area.
(13) SLOW DOWN	Indicates that ME rpm command is limited to a pre-programmed slow down level, because of a failure detected by Safety System unit.
(14) START SETPOINT	Indicates ME rpm command is limited by a preset start setpoint, Normal or Heavy start

Start interlock section

The AutoChief 4 control room unit contains a section named “START INTERLOCK”. This section contains 8 red light diode (LED) alarm indicators and indicates that start is interlocked, and cannot be started as long as the alarm is active .

INDICATOR	DESCRIPTION
(17) TURN. GEAR ENGAGED	The turning gear is engaged, ME is blocked for starting.
(18) START AIR PRESS LOW	The available start air pressure measured on the start air bottles is too low, ME is blocked for start from bridge control only.
(19) RPM DETECTOR FAIL	Both rpm detector systems are faulty. ME is blocked for start until one of the two pickup system is back in operation.
(20) SAFETY SYSTEM STOP	The Safety System has detected a critical failure and has thereby activated the stop valves. ME is blocked for starting.
(21) SAFETY SYSTEM OFF	The Safety System is turned off, or fatal error is detected internally in Safety System. ME is blocked for starting.
(23) INTERNAL INTERLOCK	The engine has stopped, but not with a stop command. To reset this start block set telegraph lever to stop position.

Start failure section

The AutoChief 4 control room unit contains a section named “START FAILURE”. This section contains 8 red light diode (LED) alarm indicators and indicates that a start attempt initiated by the system has failed.

INDICATOR	DESCRIPTION
(25) 3 START ATTEMPTS FAILED	3 start attempts are fulfilled but engine did not start. Set the lever in control to stop, and rectify failure.
(26) START TIME LIMIT	The engine did not start within the preset max. start time limit.
(27) BRAKE TIME LIMIT	The engine did reach zero rpm within the preset break time limit.
(31) ALL AUX. BLOWERS FAIL.	None of the blowers started within the preset time limit after command ahead/astern. Set lever to stop and rectify failure. None of the blowers started within the preset time limit after charge air pressure decreased to preset level for start of blowers. Rectify failure.
(32) SLOW TURNING FAILURE	Slow turning sequence was not completed. Rectify failure

Alarms/indications section

The AutoChief 4 control room unit contains a section named “ALARM/INDICATIONS”. This section contains 8 red light diode (LED) alarm indicators and indicates that various alarms and indications.

INDICATOR	DESCRIPTION
(33) SPEED PROGR. CANCELED	Speed program is cancelled, either on bridge or from engine control room.
(34) ENGINE OVERLOAD	ME governor has activated fuel limiter. RPM may drop, load up will be blocked.
(35) START AIR PRESS. LOW	The start air pressure has dropped below the preset alarm level.
(36) ENGINE CRITICAL SPEED	ME rpm has been running for too long inside the critical rpm area. Rectify failure
(37) HANDLES NOT MATCHED	Command change from bridge control has been requested from bridge, the telegraph lever in control room is not matching the lever on bridge. Set control room lever to the same level as in bridge. Bumpless control transfer can be executed.
(38) PASSIVE FAILURE	A passive failure in the remote control system has been detected.
(39) VIT & FQS FAILURE (Option)	A failure with the VIT & FQS system has been detected.
(40) SOLENOID VALVE LOOP FAIL.	A failure with one or more solenoid valves has been detected.

System failure section

The AutoChief 4 control room unit contains a section named “SYSTEM FAILURE”. This section contains 8 red light diode (LED) alarm indicators and indicates that various system failure alarms.

INDICATOR	DESCRIPTION
(41) RPM DET. SYST. 1 FAIL	The remote control system has detected failure in the internal rpm detector system. Rectify failure.
(42) RPM DET. SYST. 2 FAIL	The remote control system has detected failure in the external rpm detector system for Safety System.
(43) SPEEDSET FREEZE	Failure in the speedset signal to governor has been detected. Solenoid valve SPEEDSET FREEZE. ME rpm will be kept at same level. (Woodward hydraulic governor only)
(45) REMOTE CONTROL FAILURE	A failure with the bridge unit, or the communication to the bridge unit has been detected.
(46) TELEGRAPH FAILURE	The Remote Control System has detected a failure in the engine telegraph system.
(47) SPEED CONTROL FAIL	The remote control system has detected a failure with the Governor system. Rectify failure. (In case of electronic governor only)
(48) SAFETY SYSTEM FAIL.	The remote control system has detected a failure in the Safety System. Rectify failure.

Slow turning section

The AutoChief 4 control room unit contains a section named “SLOW TURNING”. This section contains 2 push-buttons for activation of slow turning and cylinder pre-lubrication function.

Each push-button has a light diode (LED) indicator, the indicator shows that the function has been activated and extinguishes when the function is switched off by pushing the push-button once more.

Command position section

The AutoChief 4 control room unit contains a section named “COMMAND POSITION”. This section contains 3 push-buttons for changing the control between bridge, control room and engine room (engine side).

PUSH-BUTTON

DESCRIPTION

BRIDGE
CONTROL

Press Bridge on the bridge panel. Engine Control Room answers with pressing Bridge Control. Bridge answers with Bridge Control. The control position is now from bridge.

It is also possible to ask bridge to change to bridge control.

Press Bridge Control on the engine control room panel. The LED indicator will now flicker. Bridge answers with Bridge Control. The control is now transferred to bridge control.

ENGINE ROOM CONTROL	<p>Press Engine Room Control on the bridge panel. Engine Control Room answers with pressing Engine Room Control. The control position is now Engine control room.</p> <p><i>It is also possible to force the control from bridge to engine room control.</i></p>
LOCAL CONTROL	<p>Press Engine Room Control on the engine control room panel. The control is now in engine room control. Buzzer is activated in Bridge panel. Press Engine Room Control at bridge panel, buzzer will be silenced.</p> <p>Indicates that control position is in local control. Local control can not be selected from Remote Control System but the push-button is used for accepting transfer to local control. Local control is activated by moving the fuel lever (3.12) at local stand from remote to local position.</p>

2.2.10. Reset section

The AutoChief 4 control room unit contains a section named “RESET”. This section contains 2 push-buttons for sound off and alarm acknowledgement.

PUSH-BUTTON	DESCRIPTION
SOUND OFF	Silences the buzzer (if provided but normally not used) alarms are transmitted to the alarm & monitoring system, and releases the alarm on that system.
ALARM ACKN.	Press the alarm ackn. push-button for accepting incoming alarms. The alarm lamp will change from flickering light to steady light after the alarm has been acknowledged.

3. Engine Control System (diesel engine interface) DENIS -1.

The engine control **DENIS—1** (**Diesel EN**gine **I**nterface **S**pecification) has been devised in such a manner, that various remote controls can be used (bridge, control room, engine local control).

The engine control comprises all the elements which are necessary for the operation, the monitoring and the safety of the engine.

The engine control provides for the following functions:

- Starting, operating, manoeuvring and shutting down
- Regulating the engine speed
- Partly, safeguarding and monitoring the engine

The model of main engine **Sulzer 6 RTA 72U** is included in the simulator:

- power rating - 17940 kW
- rated speed - 97 rpm
- cranking speed – 33 rpm

The engine is equipped with the governor **WOODWARD PGA 200**.

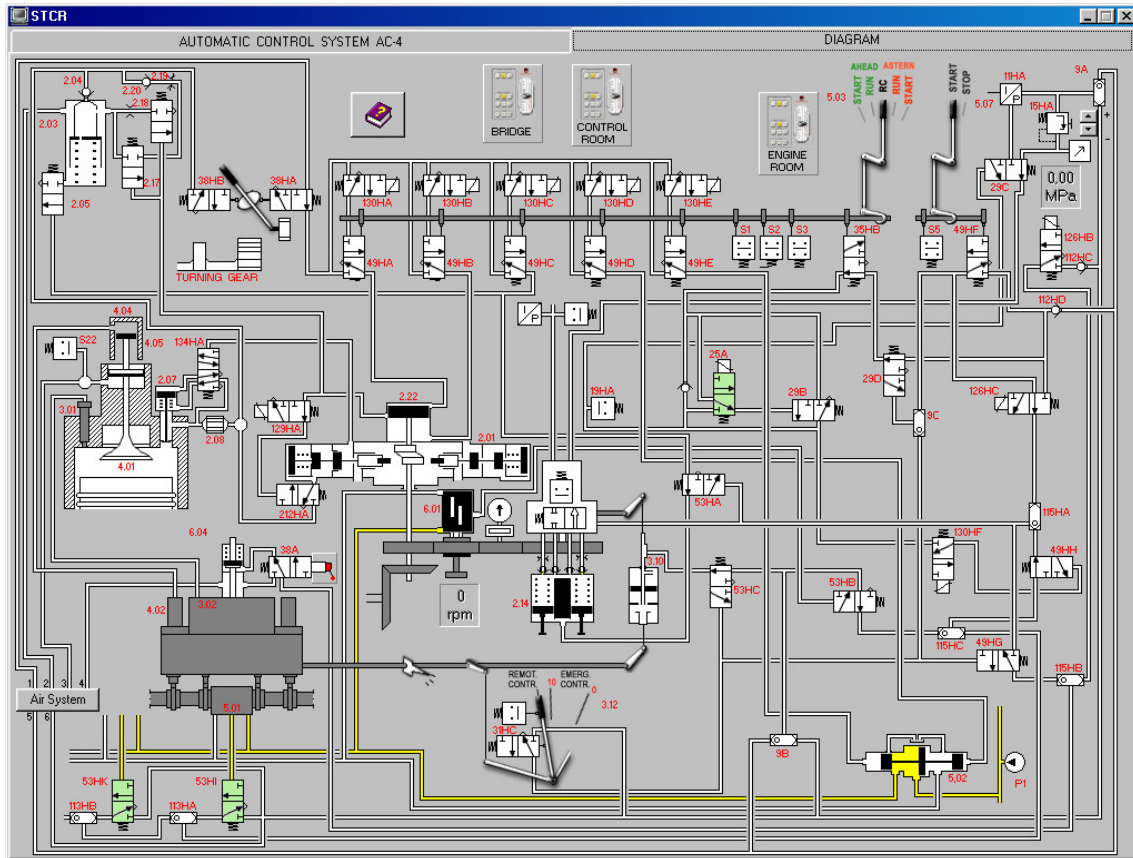

Fig. 5 Engine control system diagram

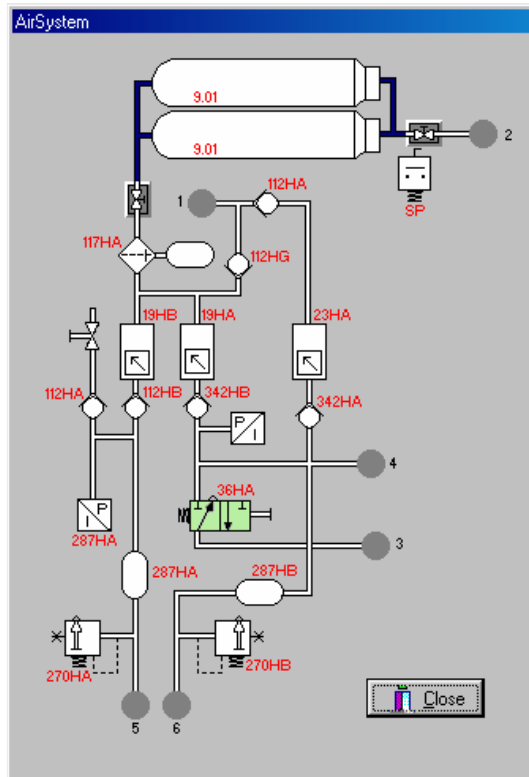
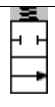

























Fig. 6 Air Station Diagram









Graphics symbols

Directional Control Valves	
	Directional Control Valves 2 port, 2 position, directional control valve, normally closed
	Directional Control Valves 3 port, 2 position, directional control valve, normally closed
	Directional Control Valves 3 port, 2 position, directional control valve, normally open
	Directional Control Valves –5 port, 2 position, directional control valve, normally open

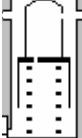
Actuators for pneumatic valves	
	Pneumatically pressurised
	Hydraulically pressurised
	Electrically actuated solenoid
	Mechanically actuated
	Roller or pneumatically actuated

Pneumatic drives	
	Single acting cylinder with return spring
	Double acting cylinder with return spring

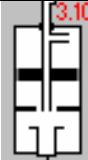
Pneumatic elements	
	Pressure gauge
	Pressure control valve
	Pressure limiting valve
	Combination unit (filter pressure control valve and pressure gauge)
	Filter with draining valve
	Shuttle valve
	Check valve
	Air storage
	Hydraulic pump
	Adjustable orifice
	Electro-pneumtical converter
	Pipe connection
	Pipe crossing

Pneumatic Control System Denis-1 elements	
	Reversing valve 5.02
	Reversing servomotor 5.01
	Shut-Off Valve for Starting Air and Valve for Slow Turning 2.03
	Starting Air Distributor 2.01
	Starting Valve 2.07
	Rotation Direction Safeguard 6.01
	Air Cylinder 3.10
	Safety Cut-out Device 6.04
	Governor

4. Operating procedures

4.1 Preparing the system

1. Open two valves on the air bottle **9.01** at air system diagram
2. Press the **STAND BY** button on Bridge Subtelegraph
3. Press the **STAND BY** button on Control Room Subtelegraph

4.2 Control from Control Room

Changing control to Control Room

1. Press the **ENGINE ROOM CONTR.** button (group **COMMAND POS.**) on Bridge Telegraph.
2. Press the **ENGINE ROOM CONTR.** button (group **COMMAND POS.**) on Control Room Panel.

Attention: Control is always set to CONTROL ROOM after starting the simulator

Starting AHEAD

1. Set the Engine Telegraph (Bridge) to position **DEAD SLOW AHEAD** (order)
2. Set the Engine Telegraph (Control Room) to position **DEAD SLOW AHEAD**

Stopping

1. Set the Engine Telegraph (Bridge) to position **STOP** (order)
2. Set the Engine Telegraph (Control Room) to position **STOP**

Starting ASTERN

1. Set the Engine Telegraph (Bridge) to position **DEAD SLOW ASTERN** (order)
2. Set the Engine Telegraph (Control Room) to position **DEAD SLOW ASTERN**

Changing revolution of the engine

1. Change position of the Engine Telegraph to the adequate field

4.3 Control from Bridge

Changing control to Bridge

1. Press the **BRIDGE CONTR.** button (group **COMMAND POS.**) on Control Room Panel.
2. Press the **BRIDGE CONTR.** button (group **COMMAND POS.**) on Bridge Telegraph.

Attention: Control is always set to CONTROL ROOM after starting the simulator

Starting AHEAD

1. Set the Engine Telegraph (Bridge) to position **DEAD SLOW AHEAD**

Stopping

1. Set the Engine Telegraph (Bridge) to position **STOP**

Starting ASTERN

1. Set the Engine Telegraph (Bridge) to position **DEAD SLOW ASTERN**

Changing revolution of the engine

1. Change position of the Engine Telegraph to the adequate field

4.4 Engine local control

In the local control the engine can be operated in two different ways:

- a) By pneumatic RPM control – LOCAL CONTROL, RPM governor intact
- b) By manual fuel charge control – EMERGENCY CONTROL, RPM governor defective

Local control with governor intact:

As soon as a lever (**5.03, 5.07, 3.12**) on the local manoeuvring stand is moved, the engine local control is activated. Local control can not be selected from Remote Control System but the LOCAL CONTROL push-button is used for accepting transfer to local control.

Starting AHEAD:

1. Move manoeuvring lever **5.03** to RUN AHEAD position.
2. Bring speed setting to start position by using **15HA** valve (+ -) (about 0,2 MPa)
3. Move manoeuvring lever **5.03** to START AHEAD position until engine runs.
4. Move manoeuvring lever **5.03** back to RUN AHEAD position.
5. Slowly increase the speed setting (+ -) until the engine runs at the required speed.

Starting ASTERN:

1. Move manoeuvring lever **5.03** to RUN ASTERN position (slow turning).
2. Bring speed setting to start position by using **15HA** valve (+ -) (about 0,2 MPa)
3. Move manoeuvring lever **5.03** to START ASTERN position until engine runs.
4. Move manoeuvring lever **5.03** back to RUN ASTERN position.
5. Slowly increase the speed setting (+ -) until the engine runs at the required speed.

Stopping:

1. Reduce local control speed setting
2. Move stop lever 5.07 to the position STOP

Emergency control:

Attention : The engine is no longer checked by the governor. This form of operation should only be managed in an emergency case of governor failure.

The fuel control lever 3.12 must be moved from the position REMOTE CONTROL and linked-in with fuel pump regulating linkage.

Starting

1. Move manoeuvring lever 5.03 to the corresponding position RUN AHEAD or RUN ASTERN
2. Move fuel control lever 3.12 to position 3 till 4.
3. Move manoeuvring lever 5.03 to START position (AHEAD or ASTERN) until the engine turns.
4. Move manoeuvring lever 5.03 back to RUN position (AHEAD or ASTERN).
5. Slowly increase fuel control lever until the engine runs at the required speed.

Stopping

1. Move fuel control lever 3.12 to 0 position
2. Move stop lever 5.07 to STOP position

Changing control from Local Control to Control Room

1. Set fuel level (3.12) to REMOTE position
2. Set local manoeuvring lever (5.03) to RC position
3. Set stop lever (5.07) to START position
4. Push the REMOTE CONTROL push-button on the Engine Room Telegraph
5. Press the **ENGINE ROOM CONTR.** button (group **COMMAND POS.**) on Control Room Panel.
6. Press the **ENGINE ROOM CONTR.** button (group **COMMAND POS.**) on Bridge Telegraph.

5. Step-by-step Mode

The step-by-step mode can be used to learn “step by step” standard operation of the system. There are four procedures in this mode:

- Slow turning astern
- Slow turning ahead
- Running astern
- Running ahead

Navigation in this mode is done by means of arrow buttons, right – for next step, left – for previous step. “Back to simulator” button can be used to return to normal simulation mode.

Please keep in mind that ‘Step-by-step mode’ means that the model calculation is stopped and the user can not operate any controls, buttons or switches.

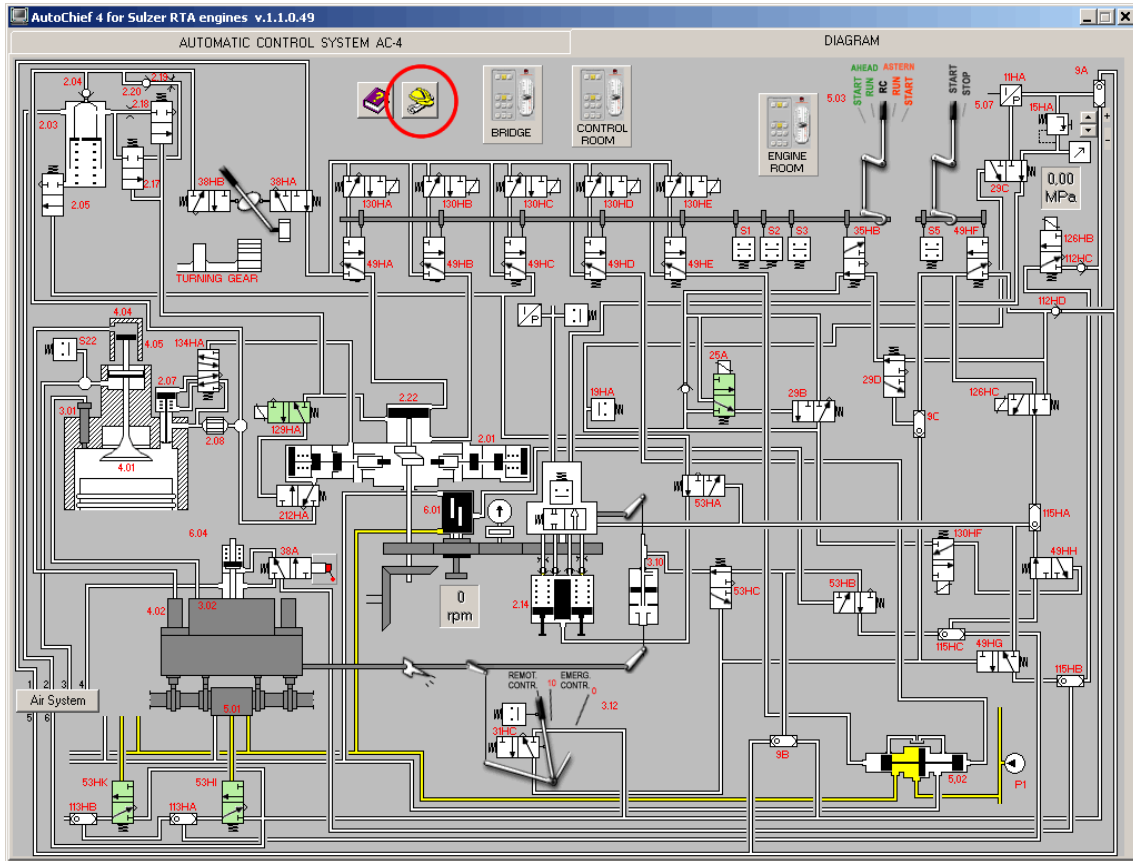

Fig. 7 Step-by-step mode start button

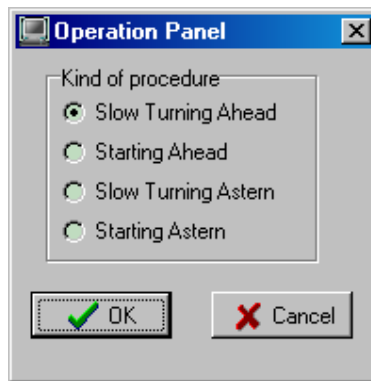

Fig. 8 Step-by-step mode operation panel

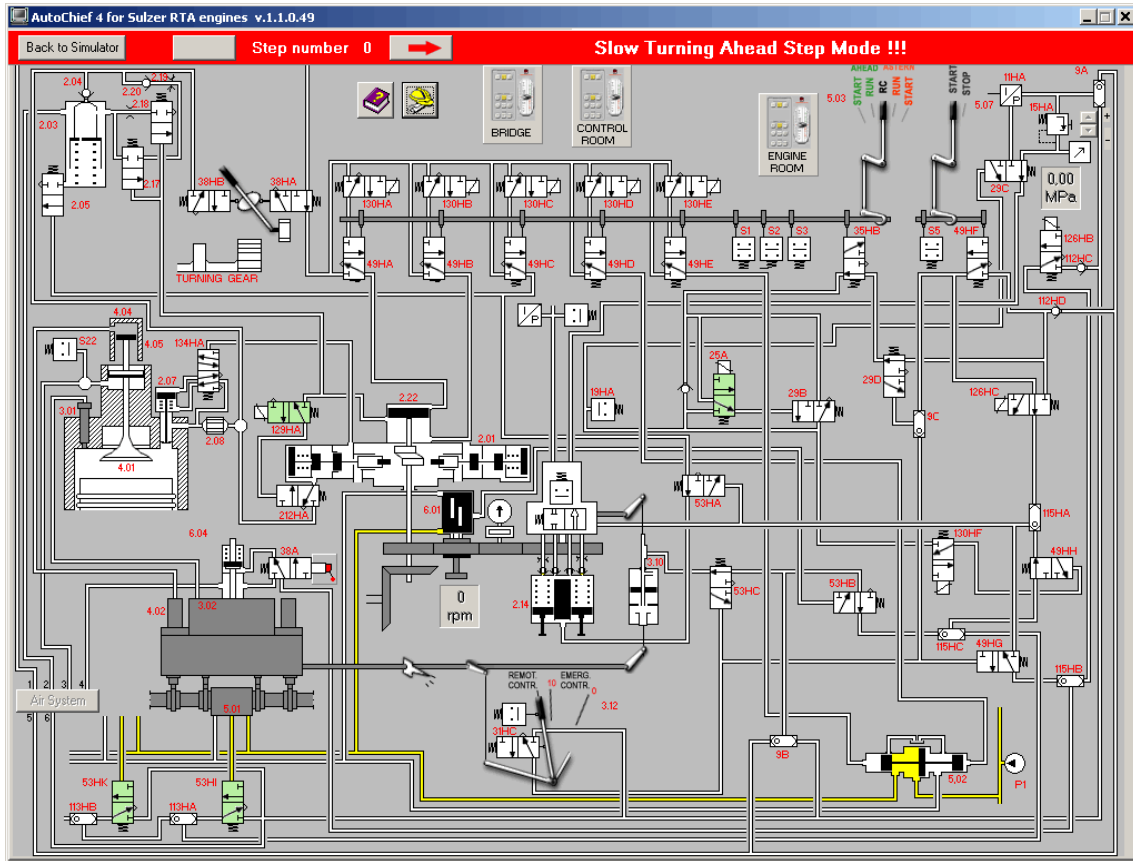

Fig. 9 Step-by-step mode

REMOTE CONTROL SYSTEM FOR MAN B&W LMC ENGINES

1. General description

The educational program **REMOTE CONTROL SYSTEM FOR MAN B&W LMC ENGINE** is intended for teaching the basic principles of how to operate a typical remote control system, that is being presently used on ships. This simulator is based on the **AUTOCHIEF-4** remote control system, produced by NORCONTROL AUTOMATION A.S., the execution of the operations is performed through engine control system **ZSPB-32**.

The program consists of the following parts:

- Engine Telegraph and Bridge Subtelegraph
- Engine Telegraph and Control Room Subtelegraph
- Engine Telegraph and Emergency Subtelegraph
- Control Room Unit Panel
- Engine Control System Diagram

After programme starting, the Control Room Unit Panel appears on the computer screen. The choice of the other panels is done by means of mouse clicking on the field of the appropriate panel (single mouse clicking of the left button).

2. Remote Control System AUTOCHIEF-4

Remote Control System AutoChief-4 is produced with utilization of microprocessor technology and it is a standard equipment of many ships' main engines.

The system consists of:

- **ENGINE TELEGRAPH (MANUAL) CONTROL SYSTEM,**
- **AUTOMATIC (REMOTE) CONTROL SYSTEM,**
- **ORDER PRINTER UNIT,**
- **SAFETY UNIT,**

Units which are available in the simulator are marked with red line on the diagram (Fig. 1).

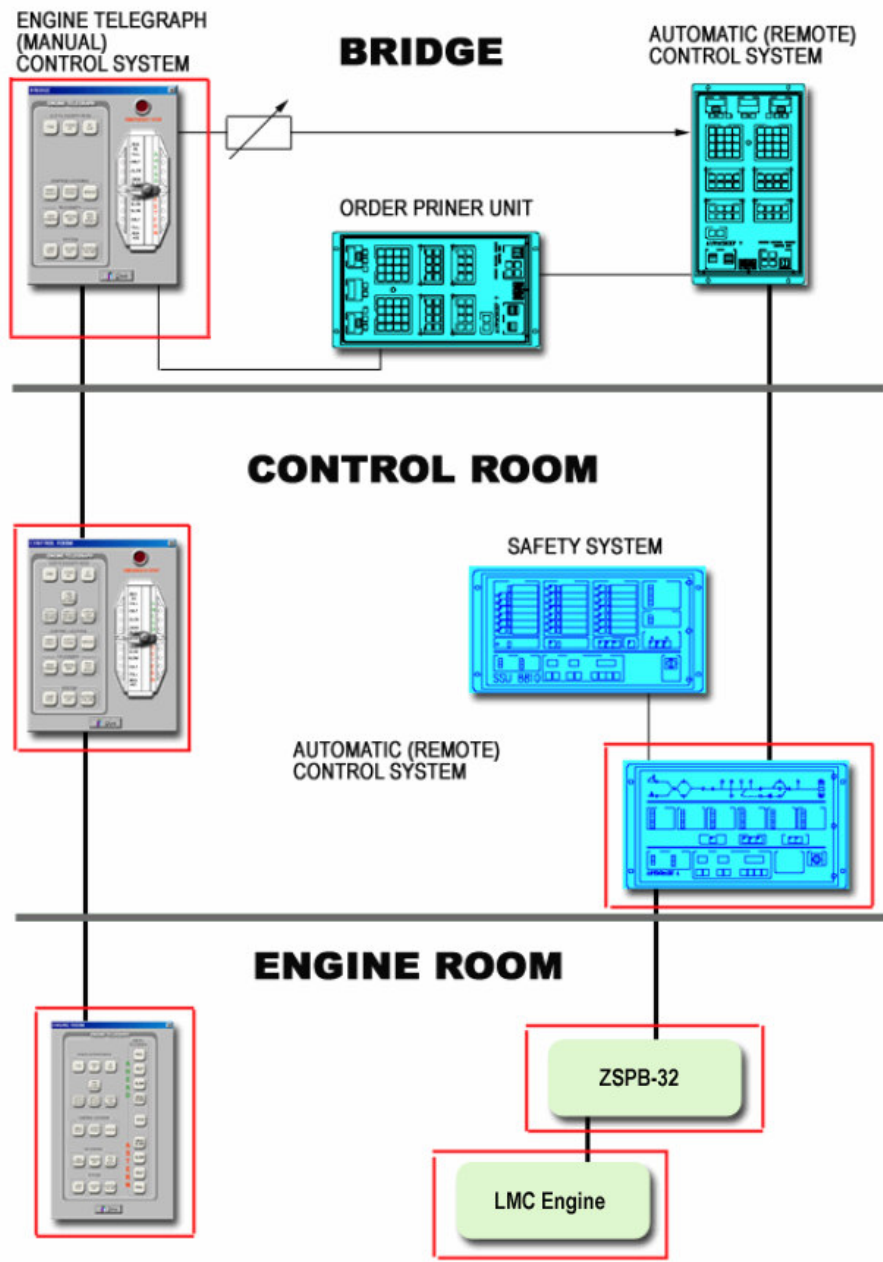

Fig. 7

2.1. Engine telegraph and subtelegraph.

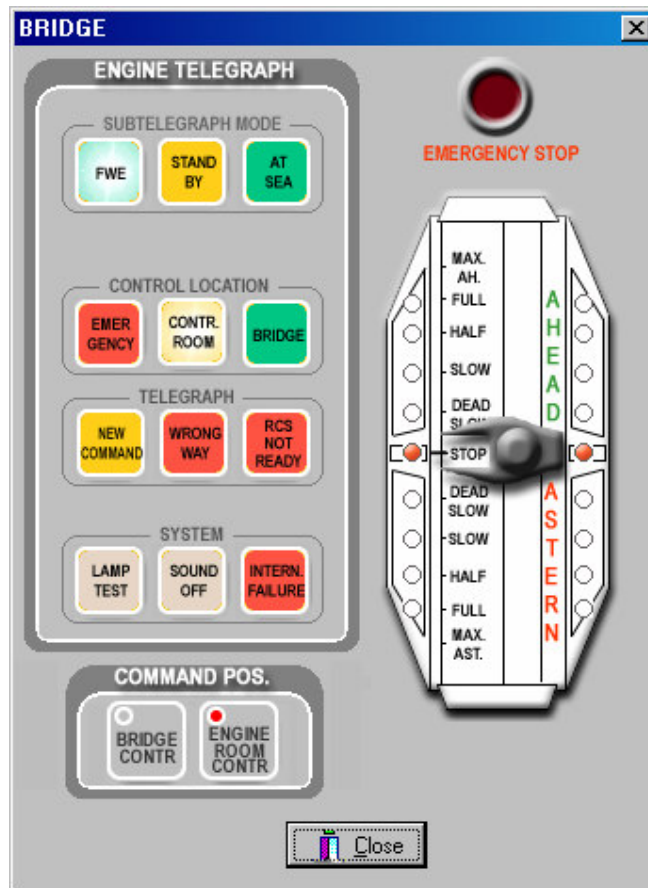

Fig. 8 Bridge telegraph

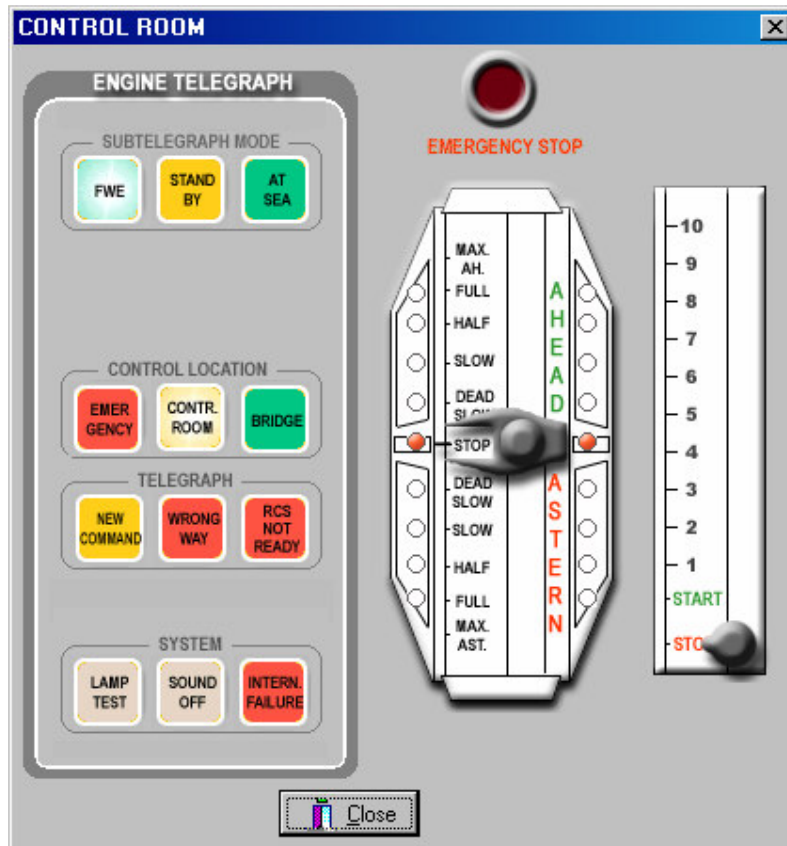

Fig.3 Control room telegraph

Engine telegraphs constitute a very important link between the bridge, control room and local engine control for transfer of messages, such as:

- Finished with engine
- Stand by
- At sea
- Wrong way alarm
- Power failure alarm
- Remote control system status
- Interface to Order Printer
- Engine control location

Engine telegraphs are designed to control the engine and comprise an Engine Telegraph unit with telegraph handle and emergency stop switch at the following location:

- Bridge
- Control room

Engine Subtelegraph contains the following buttons:

- FWE (FINISHED WITH ENGINE)
- STAND BY
- AT SEA

Bridge buttons are used for giving information and the control room buttons for confirming the information.

- FWE LOOP ABNORMAL
- CONTROL AIR NOT VENTED
- SAFETY AIR NOT VENTED
- START VALVE NOT BLOCKED
- EMERGENCY
- CONTROL ROOM
- BRIDGE
- NEW COMMAND
- WRONG WAY
- RCS NOT READY
- LAMP TEST
- SOUND OFF
- INTERNAL FAILURE

Local engine control subtelegraph is integrated with digital engine telegraph. It consists of 9 highlighted buttons which are used for confirming orders from bridge. Orders from bridge are signaled by blinking lights.

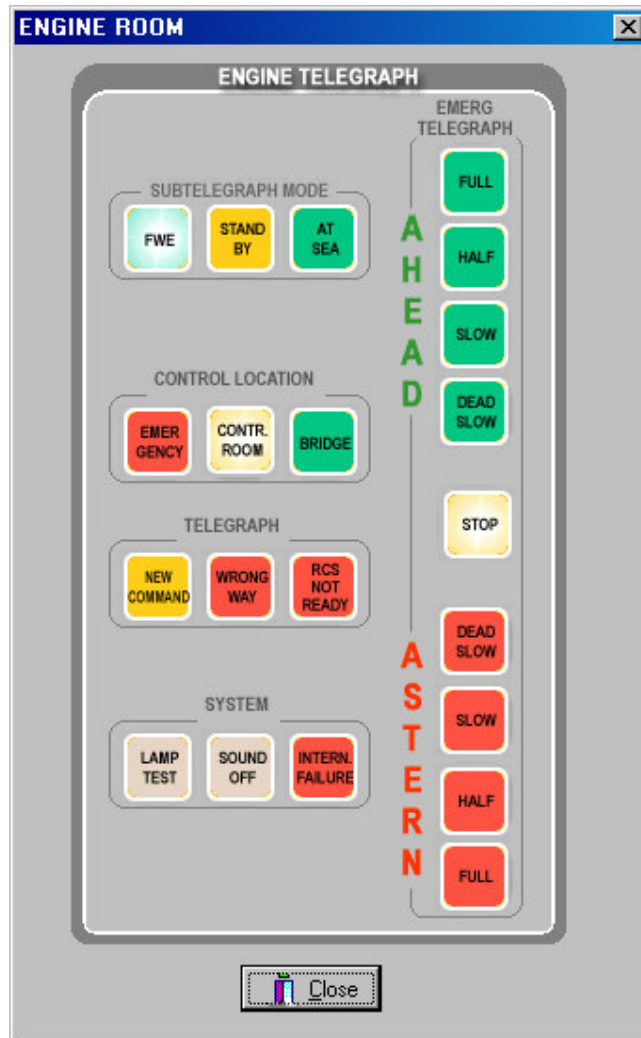

Fig. 4 Engine room telegraph

2.2. Control Room Unit Panel

The AC-4 **control room unit** consists of main electronic unit, containing a microprocessor that processes the I/O signals and is interfaced to the front panel, which is a display & control panel. The front panel enables the operator to carry out certain operations, and gives information about different status in the system. The front panel is also used for commissioning.

Simulator includes only the elements, which are directly connected with the steering process (there are no elements which are used for settings parameters of the systems).

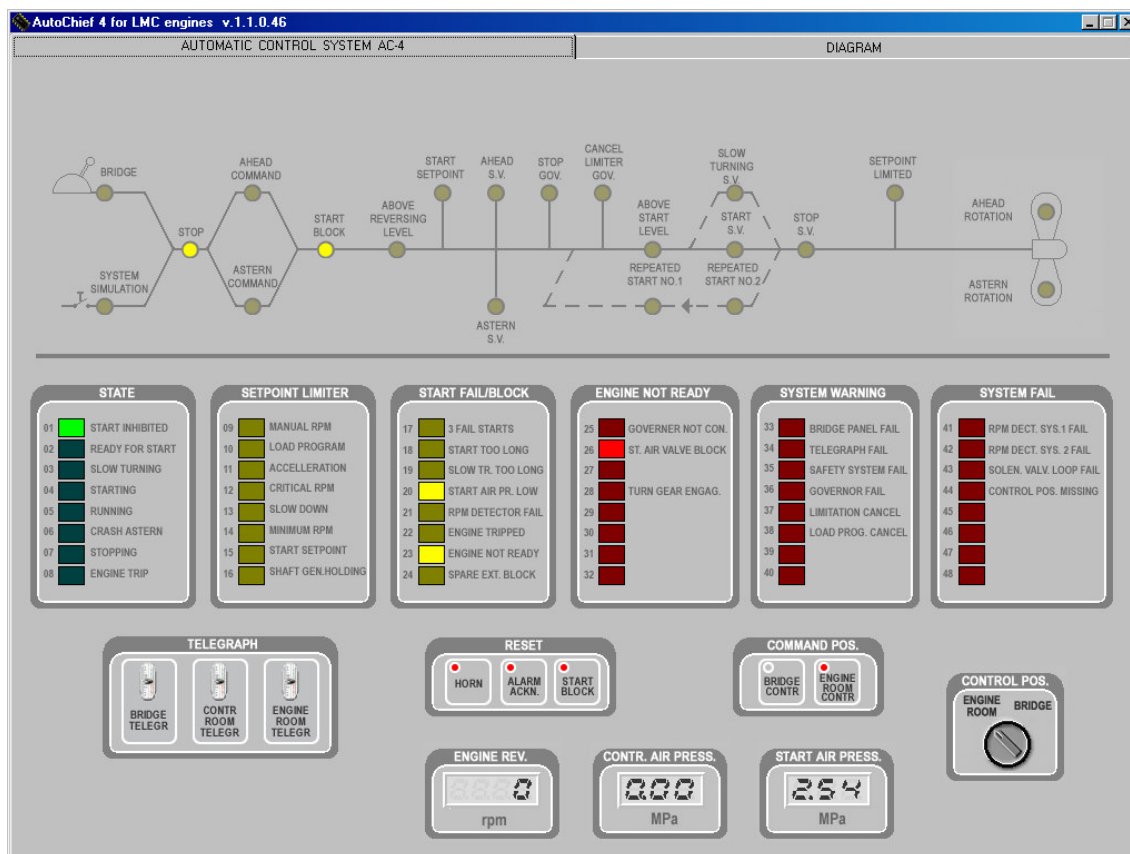

Fig. 5

Mimic diagram section

The AutoChief 4 control room unit has a mimic diagram on the top of the panel. The mimic diagram is provided to inform about the different sequences of the remote control system, and to give useful information to the user during operation of the main engine.

INDICATOR	OPERATION
Bridge / System simulation	The LED is lit on the respective control position.
STOP	When Bridge lever is in STOP position this LED is lit.
AHEAD / ASTERN	Ahead or Astern LED is lit when the bridge manoeuvre lever is moved to either Ahead or Astern position.
START BLOCK	One or more start blocks are activated - please see START FAIL/BLOCK or ENGINE NOT READY section.
ABOVE REVERSING LEVEL	Engine is running at an rpm level which is too high for reversing.
START SETPOINT	Start is activated and the governor has set out the fuel index for normal start setpoint.
AHEAD / ASTERN solenoid valves	Ahead or astern solenoid valve is energised.

STOP GOVERNOR	Signal to set governor to stop, activated from ECR Unit.
CANCEL LIMITERS GOV:	Signal to Cancel limiters in governor, activated from ECR Unit.
ABOVE START LEVEL	Main Engine is already running on fuel.
START S.V VALVE	Start S.V. is energised.
REPEATED START NO.1 / 2	The first start has failed, the system will automatically continue with repeated start no.1 and 2 (with heavy start setpoint).
STOP S.V.	The Bridge lever is set to stop and Stop S.V. is energised.
SETPOINT LIMITERS	A setpoint limiter is active – please see SETPOINT LIMITERS Section.
AHEAD ROTATION / ASTERN ROTATION	The propeller rotates according to the LED which is energised.

State section

The AutoChief 4 control room unit contains a section named “STATE”. This section contains 8 yellow light diode (LED) indicators, and informs the operator about the state of the system, and what sequence is performed .

INDICATOR	OPERATION
START INHIBITED	Start is inhibited because of a failure – described in the START FAIL/BLOCK or ENGINE NOT READY section.
READY FOR START	Engine is ready for start - all interlocks are cancelled.
SLOW TURNING	Bridge lever is set to start and slow turning is activated.
STARTING / STOPPING	Main Engine's starting / stopping sequence is activated.
RUNNING	Engine is running either Ahead or Astern.
CRASH ASTERN	Crash astern is detected and sequence is activated.
ENGINE TRIPPED	Engine has tripped because of shut down action made by Safety System unit. Check SSU to find the failure.

Setpoint limiter section

The AutoChief 4 control room unit contains a section named “SETPOINT LIMITER”. This section contains 8 yellow light diode (LED) indicators, and indicates that the engine speed is limited by a setpoint limiter, and that the present engine speed is kept lower than the speed order from manoeuvring lever.

INDICATOR	OPERATION
MANUAL RPM LIMITER	The Main Engine has reached the rpm pre-programmed by the chief engineer to be the maximum.
LOAD PROGRAM	Load Program is activated, either load increase or load decrease.
ACCELERATION	Main engines rpm is limited for acceleration.
CRITICAL RPM	Main Engine's rpm is within a pre-programmed critical rpm area. Setpoint is limited until lever command is moved from the area.
SLOW DOWN	Main Engine's rpm is limited to a pre-programmed slow down level, because Safety System unit has detected a failure.
MINIMUM RUN	The Bridge lever is set to a value which is lower than the pre-programmed rpm level which is specified as minimum run.
START SETPOINT	Main Engine is about to start and start setpoint is set to governor (either NORMAL start setpoint or HEAVY start setpoint).

Start fail/block section

The AutoChief 4 control room unit contains a section named “START FAIL/BLOCK”. This section contains 8 red light diode (LED) alarm indicators and indicates that start is interlocked, and cannot be started as long as the alarm is active.

INDICATOR	OPERATION
3 FAIL STARTS	<ol style="list-style-type: none">1. The Main Engine has tried to start 3 times.2. Set Bridge lever in stop position.
START TOO LONG	<ol style="list-style-type: none">1. The start sequence has taken too long and start has failed.2. Set Bridge lever to stop position.
SLOW TURNING FAILURE	The Main Engine has not succeeded in Slow Turning.
START AIR PRESS LOW	The available start air pressure measured on the start air bottles is too low to activate start.
RPM DETECTOR FAIL	Both rpm detector systems are faulty.
ENGINE TRIPPED	The Main Engine is tripped from the Safety System unit.
ENGINE NOT READY	The Main Engine is not ready for start. Refer to ENGINE NOT READY section.

System warning section

The AutoChief 4 control room unit contains a section named “SYSTEM WARNING”. This section contains 8 red light diode (LED) alarm indicators and indicates that various system failure alarms.

INDICATOR	OPERATION
BRIDGE PANEL FAILURE	<ol style="list-style-type: none">1. The Remote Control System has detected failure in the bridge panel.2. Rectify failure in the bridge panel.
TELEGRAPH FAILURE	<ol style="list-style-type: none">1. The Remote Control System has detected failure in the engine telegraph system.2. Rectify failure in the telegraph system.
SAFETY SYSTEM FAILURE	<ol style="list-style-type: none">1. The remote control system has detected failure in the Safety System panel.2. Rectify failure in the SSU.
GOVERNOR FAILURE	<ol style="list-style-type: none">1. The remote control system has detected failure in the digital governor system.2. Rectify failure in the DGU.
LIMITATION CANCELLED	<ol style="list-style-type: none">1. The push-button CANCEL LIMITATION is pressed on the Bridge Panel.

System failure section

The AutoChief 4 control room unit contains a section named "SYSTEM FAILURE". This section contains 8 red light diode (LED) alarm indicators and indicates that various system failure alarms.

INDICATOR	OPERATION
RPM DET. SYST. 1 FAIL	<ol style="list-style-type: none"> 1. The remote control system has detected failure in the internal rpm detector system. 2. Rectify failure in detector system 1.
RPM DET. SYST. 2 FAIL	<ol style="list-style-type: none"> 1. The remote control system has detected failure in the external rpm detector system. 2. Rectify failure in detector system 2.
SOLENOID VALVE LOOP FAIL	<ol style="list-style-type: none"> 1. The remote control system has detected failure on one or more solenoid valves. 2. Change to OP CODE 43 from the front panel and select parameter LF to check which S.V has the loop failure.
CONTROL POS. MISSING	<ol style="list-style-type: none"> 1. The remote control system does not have a defined Input from a selected control position. It is possible that air supply to pneumatic selector valve is missing. 2. Rectify failure.

Command position section

The AutoChief 4 control room unit contains a section named “COMMAND POSITION”. This section contains 3 push-buttons for changing the control between bridge, control room and engine room (engine side).

PUSH-BUTTON	OPERATION
ENGINE ROOM CONTROL (The push-button is used for requesting bridge to change to Engine Room Control).	<ol style="list-style-type: none">1. Press ENGINE ROOM CONTROL.2. Bridge answers with pressing ENGINE ROOM on the bridge panel.3. Engine Control Room replies with turning pneumatic selector valve to engine room control (Control Pos. is engine control room).
BRIDGE CONTROL	<ol style="list-style-type: none">1. Press BRIDGE CONTROL.2. Bridge answers with pressing BRIDGE on the bridge panel.3. Engine Control Room replies with turning pneumatic selector valve to BRIDGE CONTROL (Control Pos. is bridge).

Reset section

The AutoChief 4 control room unit contains a section named “RESET”. This section contains 2 push-buttons for sound off and alarm acknowledgement.

PUSH-BUTTON	OPERATION
SOUND OFF	<ol style="list-style-type: none">1. Press SOUND OFF.2. This will silence the buzzer if an alarm has occurred.

- | | |
|-------------|---|
| ALARM ACKN. | <ol style="list-style-type: none">1. Press ALARM ACKN.2. This will make a flickering LED indicator change to steady light. |
| START BLOCK | <ol style="list-style-type: none">1. Press START BLOCK.2. This will reset special start blocks without setting bridge lever to stop. |

3. Engine Control System ZSPB -32

The engine control ZSPB – 32 has been devised in such a manner, that various remote controls can be used (bridge, control room, engine local control).

The engine control comprises all the elements which are necessary for the operation, the monitoring and the safety of the engine.

The engine control provides for the following functions:

- Starting, operating, manoeuvring and shutting down
- Regulating the engine speed

Partly, safeguarding and monitoring the engine

The model of main engine type **MAN B&W - 6 L60 MC** is included in the simulator:

- power rating - 11520 kW
- rated speed - 123 rpm
- cranking speed – 12-12 rpm

The engine is equipped with the governor **WOODWARD PGA 200**.

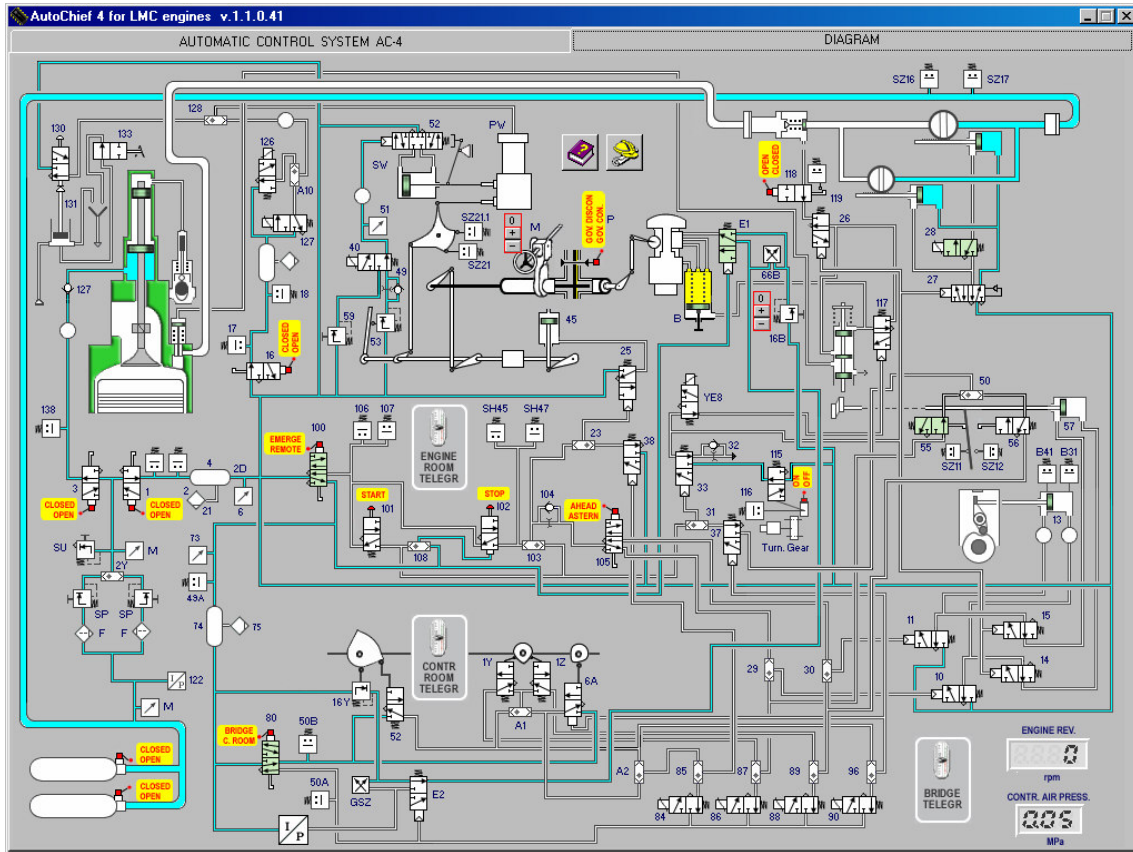
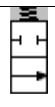

























Fig. 6 Engine control system diagram





Graphics symbols

Directional Control Valves	
	Directional Control Valves 2 port, 2 position, directional control valve, normally closed
	Directional Control Valves 3 port, 2 position, directional control valve, normally closed
	Directional Control Valves 3 port, 2 position, directional control valve, normally open
	Directional Control Valves -5 port, 2 position, directional control valve, normally open

Actuators for pneumatic valves	
	Pneumatically pressurised
	Hydraulically pressurised
	Electrically actuated solenoid
	Mechanically actuated
	Roller or pneumatically actuated

Pneumatic drives	
	Single acting cylinder with return spring
	Double acting cylinder with return spring

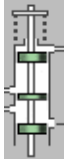
Pneumatic elements	
	Pressure gauge
	Pressure control valve
	Pressure limiting valve
	Combination unit (filter pressure control valve and pressure gauge)
	Filter with draining valve
	Shuttle valve
	Check valve
	Air storage
	Hydraulic pump
	Adjustable orifice
	Electro-pneumal converter
	Pipe connection
	Pipe crossing

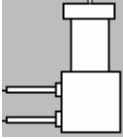
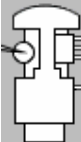
Pneumatic Control System ZSPB 32 - elements	
	Main Starting Valve
	Slow Turning Valve
	Starting Valve
	Starting Air Distributor
	Reversing mechanism
	Fuel Pump
	Governor

4. Operating procedures

4.1 Preparing the system

1. Open one of air valves on the air bottle.
2. Press the **STAND BY** button on Bridge Subtelegraph
3. Press the **STAND BY** button on Control Room Subtelegraph

4.2 Manual Control from Control Room

Changing control to Control Room

1. Set the valve **100** into position **REMOTE**
2. Press the **ENGINE ROOM CONTR.** button (group **COMMAND POS.**) on Bridge Telegraph.
3. Press the **ENGINE ROOM CONTR.** button (group **COMMAND POS.**) on Control Room Panel.
4. Set pneumatic change-over valve (group **CONTROL POS.** on Control Room Panel) to position Engine Room.

Starting AHEAD

1. Set the Engine Telegraph (Bridge) to position **DEAD SLOW AHEAD**
2. Set the Engine Telegraph (Control Room) to position **DEAD SLOW AHEAD**
3. Set the regulating handle to position **START**
4. When engine reaches above 10 rpm move the regulating handle into position 2

Stopping

3. Set the Engine Telegraph (Bridge) to position **STOP**
4. Set the Engine Telegraph (Control Room) to position **STOP**
5. Set the regulating handle (Control Room) to position **STOP**

Starting ASTERN

1. Set the Engine Telegraph (Bridge) to position **DEAD SLOW ASTERN**
2. Set the Engine Telegraph (Control Room) to position **DEAD SLOW ASTERN**
3. Set the regulating handle to position **START**
4. When engine reaches above 10 rpm move the regulating handle into position 2

Changing revolution of the engine

1. Change position of the regulating handle to the adequate field

4.3 Automatic Control from Bridge

Changing control to Bridge

1. Set the valve **100** into position **REMOTE**
2. Press the **BRIDGE CONTR.** button (group **COMMAND POS.**) on Bridge Telegraph.
3. Press the **BRIDGE CONTR.** button (group **COMMAND POS.**) on Control Room Panel.
4. Set pneumatic change-over valve (group **CONTROL POS.** on Control Room Panel) to position Bridge.

Starting AHEAD

1. Set the Engine Telegraph (Bridge) to position **DEAD SLOW AHEAD**

Stopping

1. Set the Engine Telegraph (Bridge) to position **STOP**

Starting ASTERN

1. Set the Engine Telegraph (Bridge) to position **DEAD SLOW ASTERN**

Changing revolution of the engine

1. Change position of the Engine Telegraph to the adequate field

4.4 Engine local control

In the local control the engine can be operated in two different ways:

- a) By pneumatic RPM control – LOCAL CONTROL, RPM governor intact
- b) By manual fuel charge control – EMERGENCY CONTROL, RPM governor defective

Local control with governor intact:

Changing control to Local Control

1. Set the valve **100** into position **EMERGENCY**

Starting AHEAD:

1. Set the valve **105** into position **AHEAD**
2. Push the **STOP** valve **102** until fuel pump and starting air distributor reverse
3. Set the control air pressure to 0,2 – 0,3 MPa by using pressure control valve **16B(+ -)**
4. Push the **START** valve **101** until the engine reaches above 12 rpm

Starting ASTERN:

1. Set the valve **105** into position **ASTERN**
2. Push the **STOP** valve **102** until fuel pump and starting air distributor reverse
3. Set the control air pressure to 0,2 – 0,3 MPa by using pressure control valve **16B(+ -)**
4. Push the **START** valve **101** until the engine reaches above 10 rpm

Stopping:

1. Push the **STOP** valve **102**

Emergency control:

Attention : The engine is no longer checked by the governor. This form of operation should only be managed in an emergency in case of governor failure.

Starting

1. Set hand wheel P to position GOV. DISCON.
2. Increase fuel lever using the wheel M (+ -)
3. Push the START valve 101 until the engine reaches above 12 rpm

Stopping

1. Push the STOP valve 102

5. Step-by-Step Mode

The step-by-step mode can be used to learn “step by step” standard operation of the system. There are four procedures in this mode:

- Start from Local Control
- Start from Control Room
- Start from Bridge

Navigation in this mode is done by means of arrow buttons, right – for next step, left – for previous step. “Back to simulator” button can be used to return to normal simulation mode.

Please keep in mind that ‘Step-by-step mode’ means that the model calculation is stopped and the user can not operate any controls, buttons or switches.

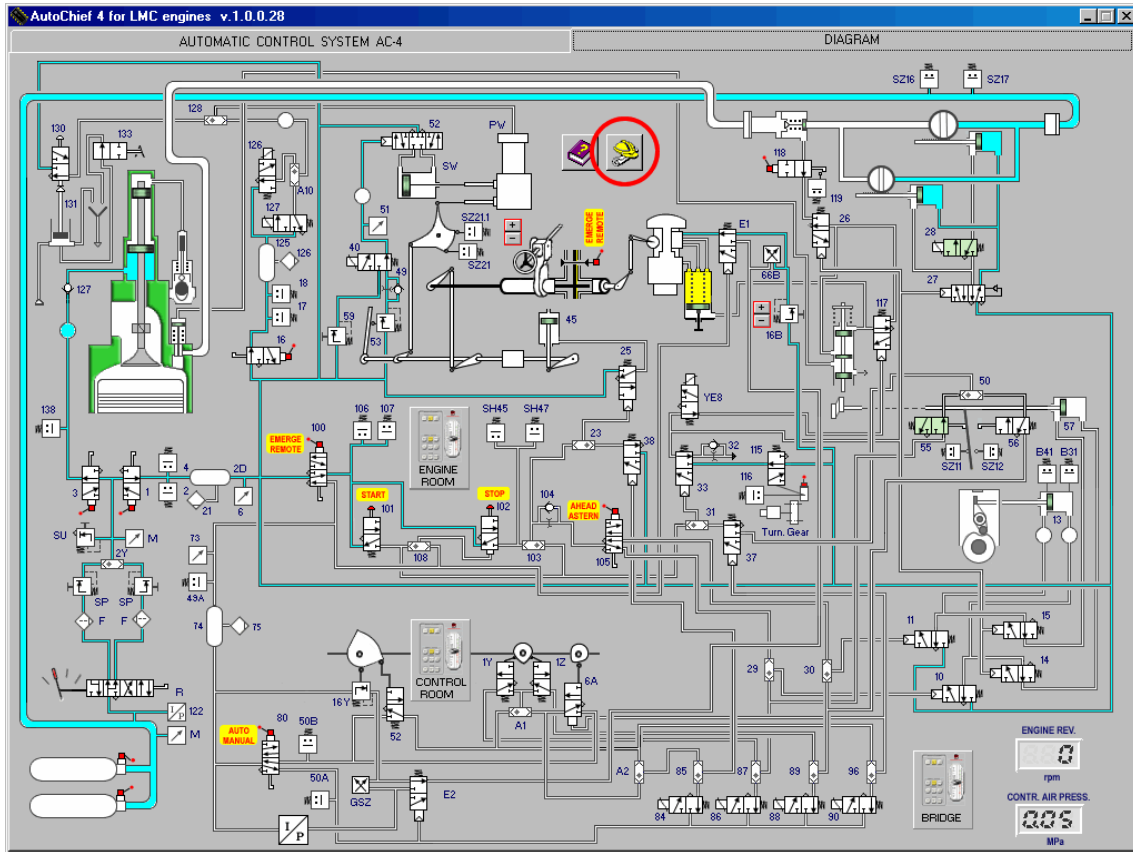

Fig. 7 Step-by-step mode start button

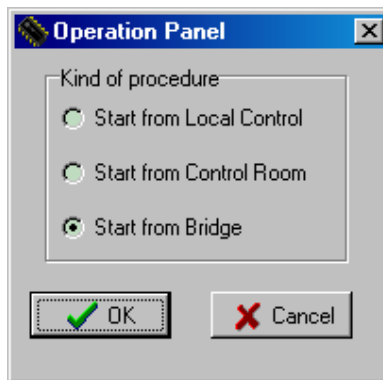

Fig. 8 Step-by-step mode operation panel

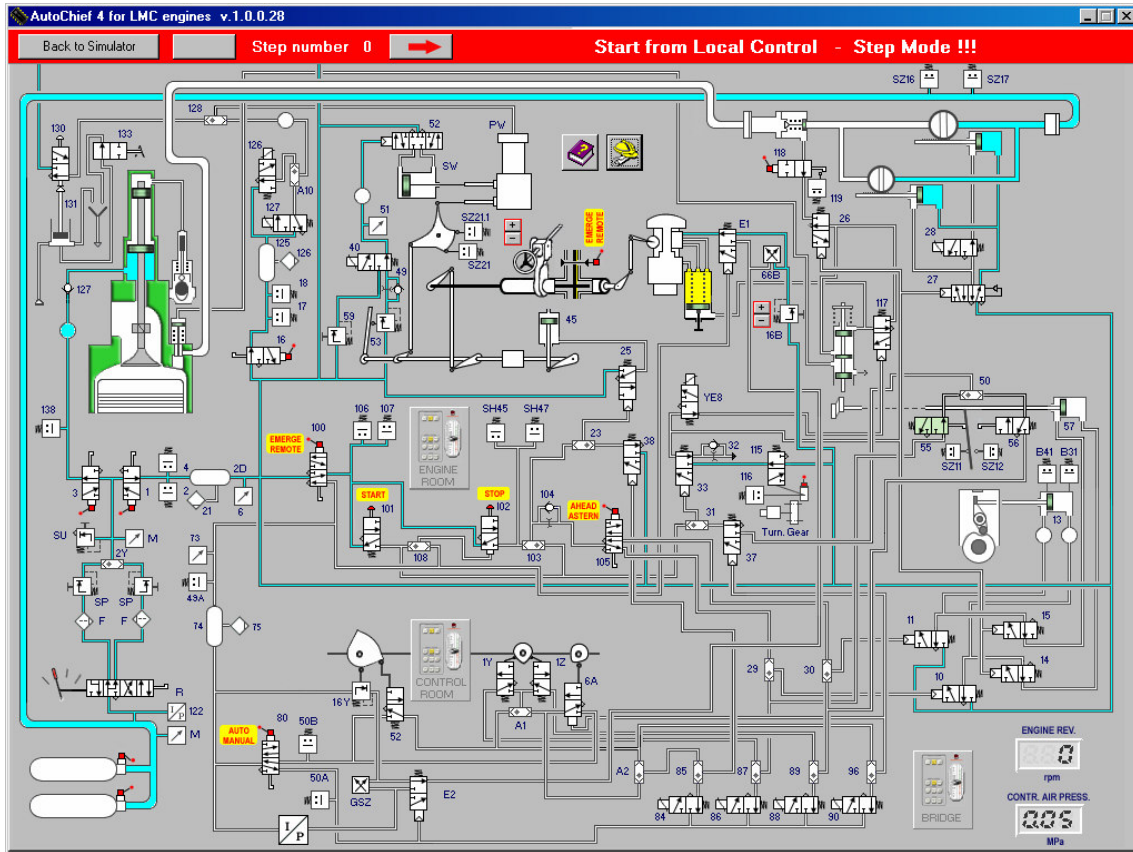

Fig. 9 Step-by-step mode

REFRIGERATION PLANT

1. General description.

The educational program REFRIGERATION PLANT - training simulator, is designated for learning the essential principles of the refrigeration room maintenance. The program is based on a refrigerating plant with two cold chambers . The cold chamber number 1 serves to obtain minus temperatures ranging from - 30 to - 15 °C while the cold chamber 2 serves to achieve temperatures from 0 to +15 °C. The chambers are serviced by one piston compressor. The refrigerant medium is freon R 22.

The program consists of the following three parts:

- the control panel,
- the installation diagram,
- the regulator and safety devices diagrams.

The choice of the two first parts of the program is done by mouse clicking at the strip in the upper part of the screen.

The choice of the third part of the program is done by mouse clicking in the field of the appropriate regulator (low pressure safety cut-out LPC, high pressure safety cut-out HPC, differential pressure control DPC, thermostats TER 1 and TER 2) on the installation diagram /fig.2/.

THE CONTROL PANEL /fig. 1/ includes:

- alarm block with lamps:

- a) high pressure /EMERG.STOP HIGH PRESS./,
- b) low lubricating oil pressure /EMERG.STOP OIL LOW PRESS./.

- switch block:

- a) on/off main switch,
- b) on/off condenser cooling water pump,
- c) on/off compressor,
- d) air cooler defrosting timer.

- control lamp block:

- a) fans /START/,
- b) solenoid shut-off valves /START/,
- c) compressor /START/,

- d) main switch /START/,
 - e) condenser cooling water pump /START/,
 - f) compressor /START/,
 - g) defrosting cycle start /DEFROSTING START/,
 - h) electric heaters in the air cooler in the chamber 1 on /EVAP. HEATER ON/.
 - i) compressor stand - by /STAND BY/.
- push - buttons:
- a) manual defrosting on /MANUAL DEFROST./,
 - b) alarm confirmation /ALARM CONFIRMATION/,
 - c) lamp testing /LAMPS TEST/.

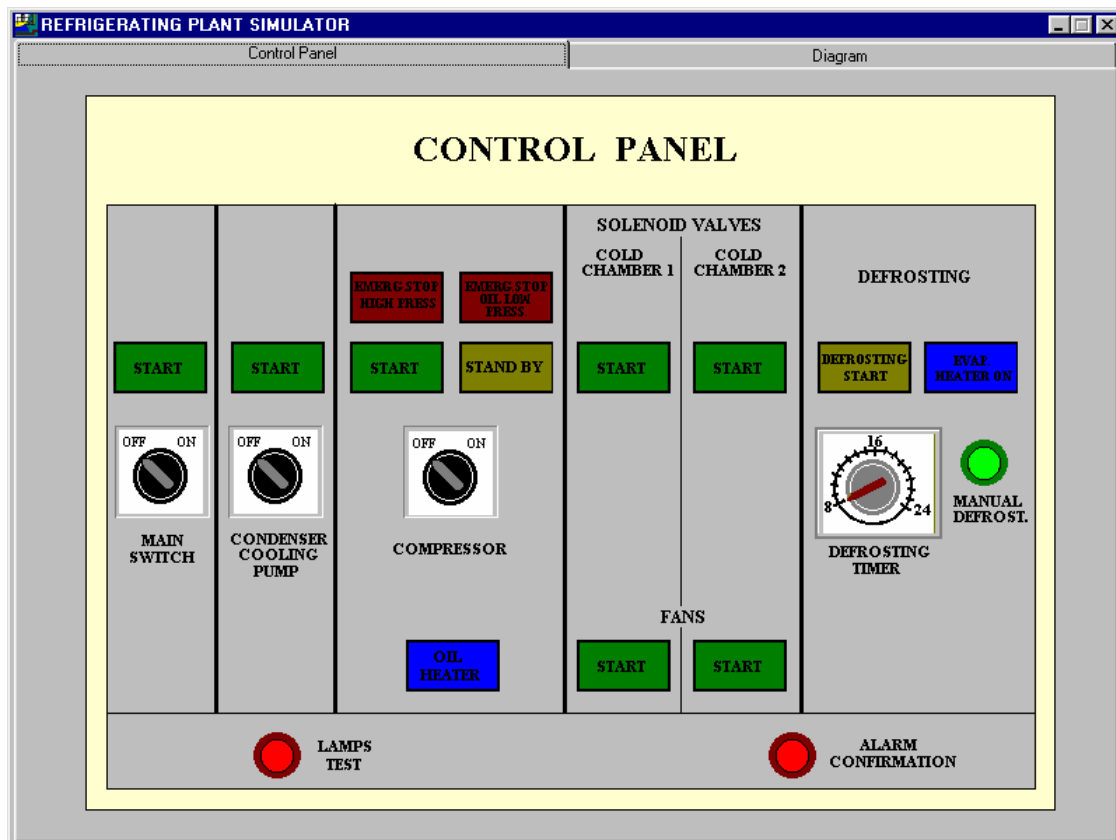

Fig. 1 Control panel

THE REFRIGERATING PLANT diagram consists of /fig.2/:

- piston compressor,
- automatic oil separator,
- dehydrator,
- shell and coil condenser,
- two cold chambers (chamber 1 - minus temperature, chamber 2 - plus temperature),
- measurement and control devices, regulators and safety devices (thermostats, pressure controls).

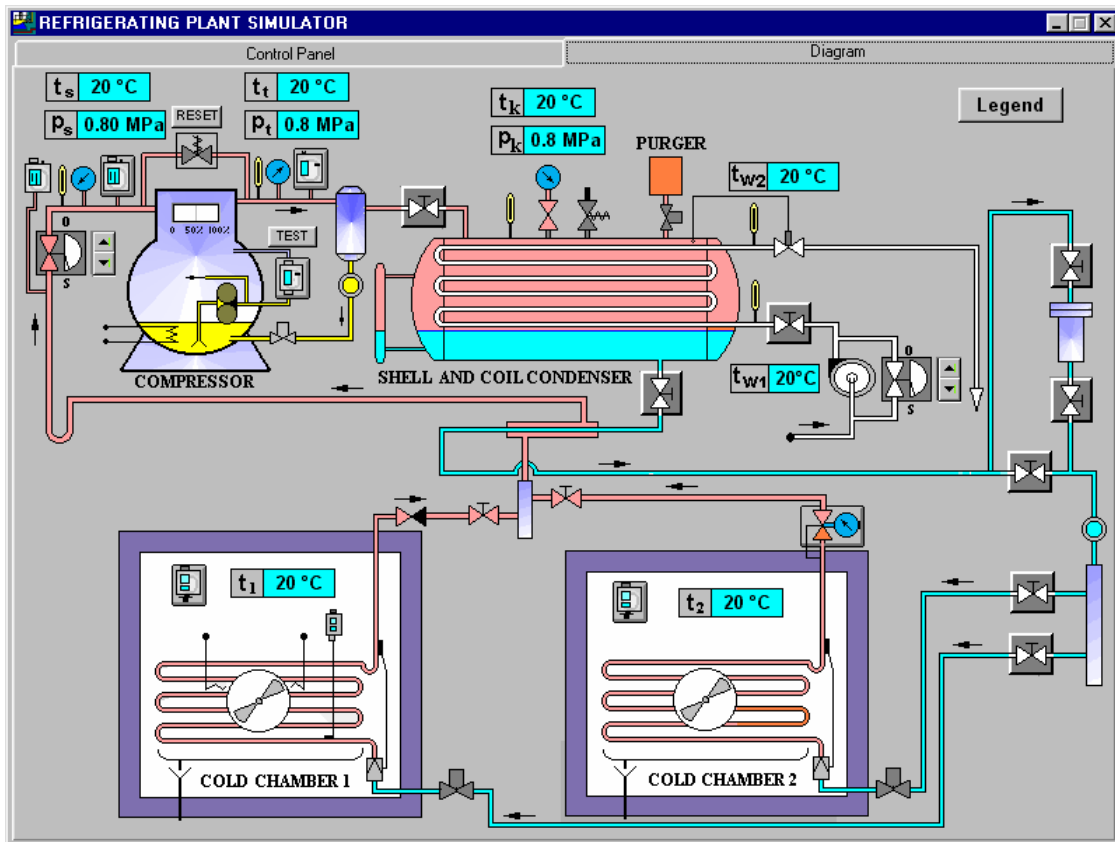

Fig. 2 Refrigerating plant diagram

Graphic symbols which are used at the refrigerating plant installation diagram are described in the LEGEND /fig.3/.

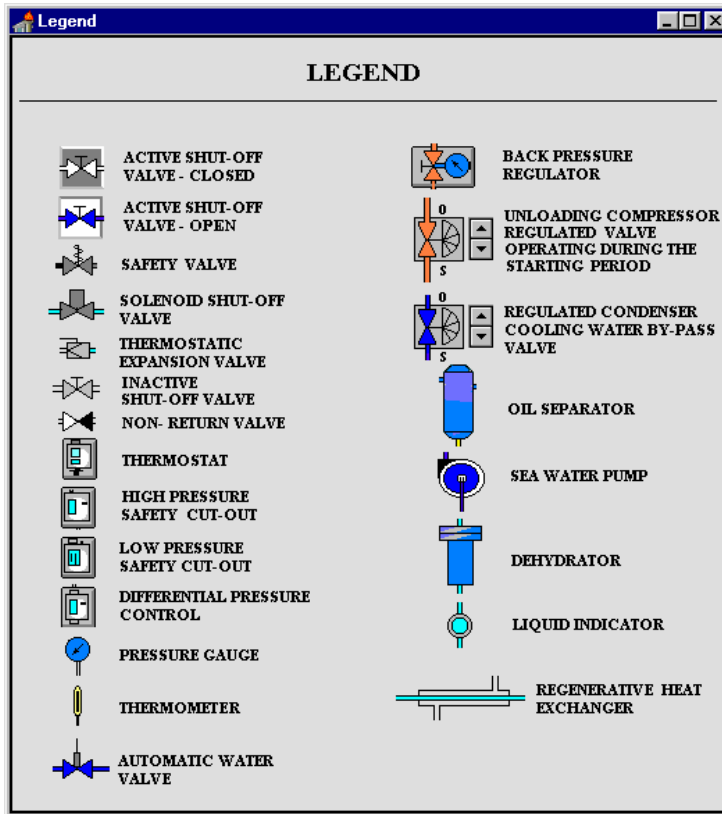

Fig. 3 Legend

Regulators and safety devices diagrams contains:

- low pressure safety cut-out diagram LPC /fig. 4/,
- high pressure safety cut-out diagram HPC /fig.5/,
- differential pressure control diagram DPC /fig.6/,
- chamber 1 thermostat diagram TER 1 /fig.7/,
- chamber 2 thermostat diagram TER 2 /fig.7/,
- back pressure regulator diagram BPR.

Attention:

Push - buttons and switches operation is done by mouse clicking the marked field.

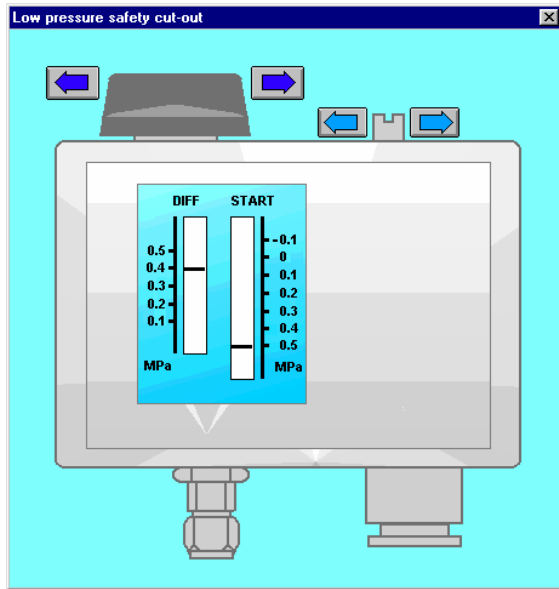

Fig. 4 Low pressure safety cut-out diagram /LPC/

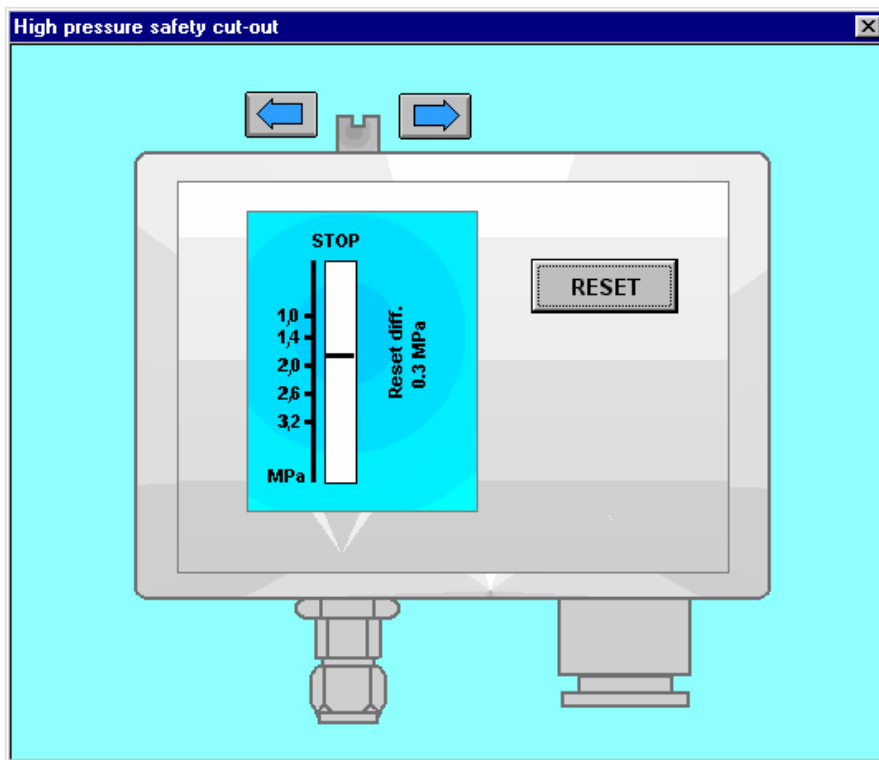

Fig. 5 High pressure safety cut-out diagram /HPC/

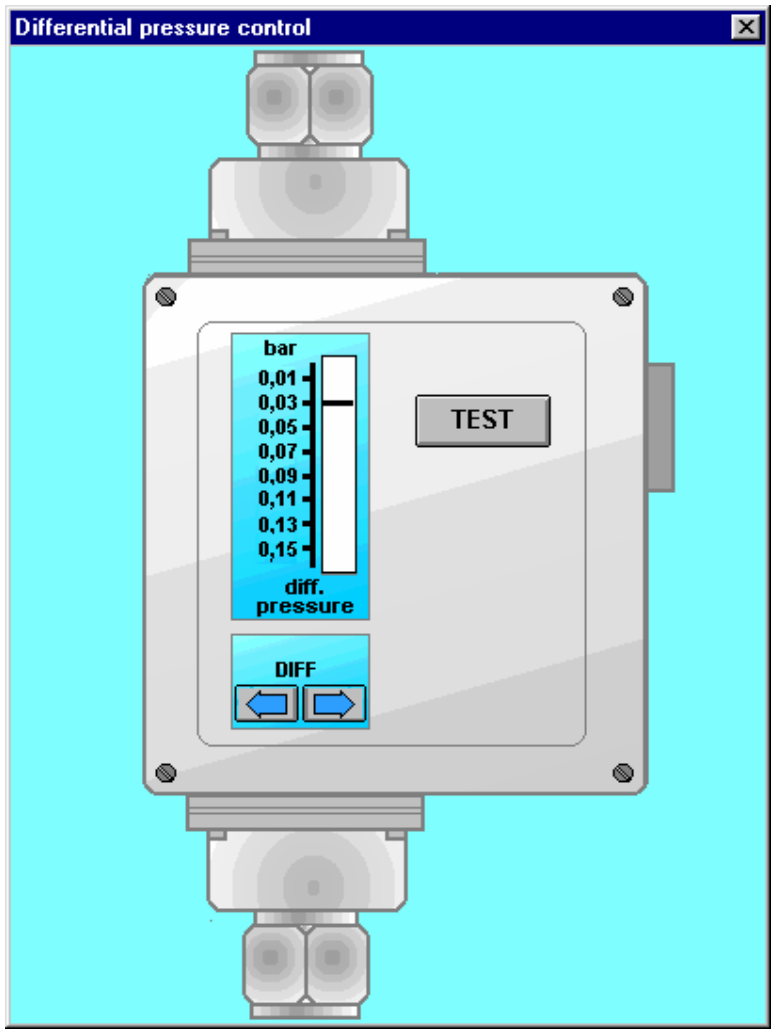

Fig. 6 Differential pressure control diagram /DPC/

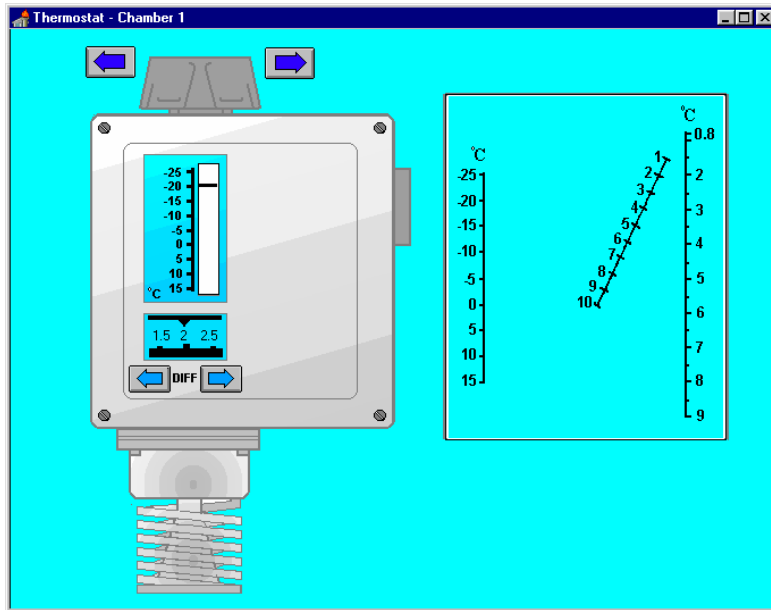

Fig. 7 Thermostat diagram /TER/

2. Operating instruction

After program starting all devices are off and valves are closed.

Starting parameters:

- suction line temperature $t_s = 20\text{ °C}$,
- compression temperature $t_t = 20\text{ °C}$,
- condensation temperature $t_k = 20\text{ °C}$,
- condenser cooling water temperature t_{w1} and $t_{w2} = 20\text{ °C}$,
- temperature in chambers t_1 and $t_2 = 20\text{ °C}$,
- evaporator pressure $p_s = 0,80\text{ MPa}$,
- compression pressure $p_t = 0,8\text{ MPa}$,
- condensation pressure $p_k = 0,8\text{ MPa}$.

The compressor is unloaded during start (there is no pressure difference between the suction line and the compression side).

Regulator's setting while starting the program:

- low pressure safety cut-out /LPC/:
 - a) START 0,5 MPa,
 - b) difference DIFF 0,4 MPa.
- high pressure safety cut-out /HPC/:
 - a) STOP 1,8 MPa.
- Differential pressure control /DPC/:
 - a) DIFF 0,003 MPa.
- thermostat in the chamber 1 /TER 1/:
 - a) setting - 20 °C,
 - b) DIFF 2.
- thermostat in the chamber 2 /TER2/:
 - a) setting + 10 °C,
 - b) DIFF 2.

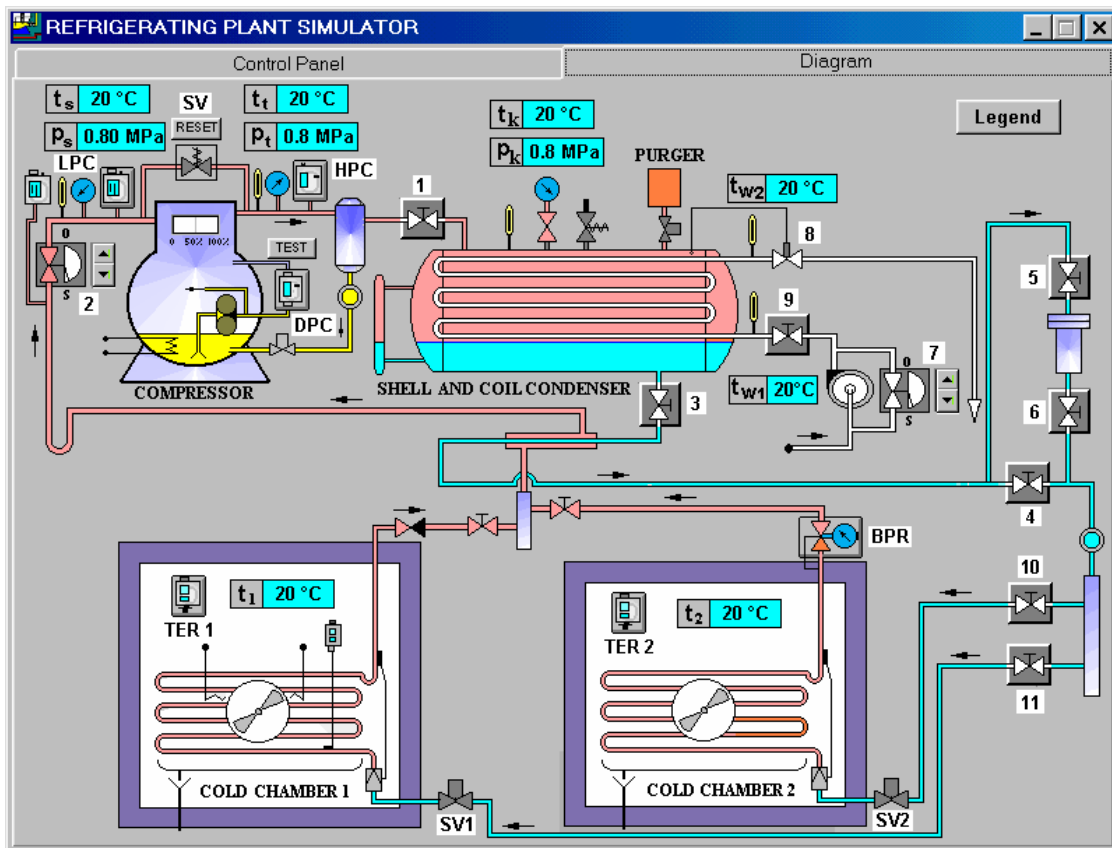

Fig. 8 Refrigerating plant diagram with valves and control devices description

3. Starting procedure

1. Open valves 1,7,5,6,10 and 11 /fig.8/,
2. Open valve 2 (shut-off valve placed at suction compressor line with six positions possible) by mouse clicking in the arrow field in 'o' direction.
3. Turn on the main switch (point and click with the mouse in the proximity of 'ON'. Switching on is confirmed by a green lamp 'START'. If temperature in chambers is higher than the setting temperatures on the proper thermostat then the green lamps 'START' of the fans and the solenoid valves shall light, indicating their activity.
4. Switch on the condenser cooling water pump (point and click with the mouse in the proximity of 'ON'). Switching on is confirmed by green lamp 'START'.

5. Start the compressor (point and click with the mouse in the proximity of 'ON') The yellow lamp 'STAND BY' indicates that the compressor is ready to work. At the same time the blue lamp 'OIL HEATER' lights indicating that lubricating oil in the compressor crankcase is heated. The compressor starts (the green lamp 'START' turns on while the lamp 'OIL HEATER' turns off) when suction pressure p_s , (shown in display) increases above the setting pressure at the low pressure safety cut-out LPC. The compressor stops when the suction pressure will be lower than stop compressor pressure set on LPC. START - DIFF = STOP.
6. After switching on the compressor by setting switch at 'ON' position, open valve 3 /fig. 8/.

Attention:

1. The compressor capacity is automatically regulated on the level of 50 or 100%. The compressor load indicator is located in the upper part of the compressor. It depends on the number of the working cold chambers /two green light indicate that two chambers are in service -compressor capacity 100%, one green light indicates that one chamber is in service - compressor capacity 50% /.
2. If valve 2 is not opened, the compressor starts and works till suction pressure p_s decreases to a level lower than the pressure set at the low pressure safety cut-out LPC. When the suction pressure reaches this level, the compressor is automatically stopped. The compressor starts again when the suction pressure increases higher than the value set at the LPC.
3. If valve 1 is not opened /fig. 8/, the compressor starts and will work until compression pressure p_t becomes higher than the pressure set at the high pressure safety cut-out HPC. Then the compressor stops and the red alarm lamp 'EMERG. STOP HIGH PRESS' turns on and the alarm sounds. In order to repeat the compressor start it is necessary to open valve 1 and wait until pressure decreases to about 1,4 MPa. Then it is necessary to reset the high pressure safety cut-out HPC by mouse clicking the button 'RESET' on HPC diagram. When pressure set at the HPC exceeds 2,1 MPa (in case of excessive pressure), the safety valve 'SV' acts (the valves field lights red), connecting the compressor suction and compression sides. If the compression pressure p_t decreases to the value about 1,4 MPa, then by mouse clicking press the button 'RESET' placed over the safety valve in order to unlock it.
4. If valve 3 is not opened /fig. 8/ the compressor starts and will work until all refrigerant vapour from the chamber evaporators is sucked off and suction pressure p_s decreases lower than pressure set at the low pressure safety cut-out LPC. The compressor starts automatically when suction pressure increases over the value set at the LPC.
5. If valves 5, 6 or 4 and 10, 11 /fig. 8/ are not opened, the situation above described at point 4, occurs.

6. If only the valve 10 /fig. 8/ is not opened, the compressor starts and works automatically but the temperature in the chamber 2 rises due to the lack of refrigerant in the evaporator.
7. If only the valve 11 /fig. 8/ is not opened the compressor starts and works automatically, but temperature in the chamber 1 rises due to the lack of the refrigerant in the evaporator.
8. If condenser cooling water pump is off the compressor starts and works until an increase of the condensing pressure p_k occurs and consequently the compression pressure p_t increases over the value set at the high pressure safety cut-out HPC. The high pressure alarm lamp 'EMERG.STOP HIGH PRESS' turns on and the alarm sounds. It will be possible to repeat the compressor start only after the pressure decreases to the value of about 1,4 MPa, by pressing the button 'RESET' on HPC diagram.
9. If valve 9 /fig.8/ is not opened there is an increase of the condensing pressure p_k , condensing temperature t_k and compressing pressure p_t . If this increase exceeds the pressure set at the HPC, the compressor stops. The high pressure alarm lamp 'EMERG.STOP HIGH PRESS' turns on and the alarm sounds. To repeat compressor start - see procedure point 3 or 8.
10. During normal exploitation, the condenser is cooled by the pressure - controlled valve 8 /fig.8/. The condenser cooling water flow is regulated by means of by pass valve 7 (by pass valve with 4 positions possible). Mouse clicking in the arrow field in 'o' direction. increases the condensing temperature t_k , condensing pressure p_k and condenser cooling water temperature t_{w2} , while clicking in direction 's' decreases these parameters.
11. If the pressure difference in the compressor lubricated oil system is lower than the difference set on the differential pressure control DPC (0,03 Mpa), the compressor starts and stops immediately (time delay - about 3 sec). On the control panel 'EMERG.STOP OIL LOW PRESS' lamp turns on and the alarm sounds.
12. It is possible to check the functioning of the differential pressure control DPC by mouse clicking on the button 'TEST' (placed on the diagram, over DPC). The compressor should stop and start after 'TEST' button release.
13. The push - button 'LAMPS TEST ' serves to check the proper functioning of the control lamps.

4. Continuous running procedure

After starting the refrigerating plant according to the procedure described above, the refrigerating plant works in an automatic cycle. The chamber temperatures decrease gradually until temperatures reach values set at the proper thermostat. Then the solenoid valve is automatically closed (valve SV 1 or SV 2 changes colours) and fans are switched off. After standing period, when temperature in the particular cold chamber rises over the value set on the thermostat, the solenoid valve opens automatically (the valve SV 1 or SV 2 changes colours) and fan turns on.

The following parameters:

- suction pressure p_s ,
- suction line temperature t_s ,
- compression temperature t_c ,
- compression pressure p_c ,
- condensing temperature t_k ,
- condensing pressure p_k ,

are continually changing, (this depends on the cold chambers temperature and number of the chambers being in service). The values of these parameters are shown in the corresponding displays on diagram / fig.2/.

Attention:

1. If valve 2 is closed /fig.8/, after a few seconds the low pressure safety cut-out stops the compressor. When suction line pressure increases over the value set on the LPC the compressor starts automatically.
2. During compressor standing, in the event the temperature in chambers increases over the set temperature on TER, thermostat causes the solenoid valve opening and the fan switches on.
3. If valve 1 is closed /fig.8/ after a few seconds the compressor stops due to the increasing compression pressure over the value set on the high pressure safety cut-out. The high pressure alarm lamp 'EMERG.STOP HIGH PRESS' turns on and the alarm sounds. It will be possible to repeat the compressor start only after the pressure decreases to the value of about 1,4 MPa, by pressing the button 'RESET' on HPC diagram.
4. If valve 3 is closed /fig.8/ the compressor stops after suction pressure decreases below the value set on the low pressure safety cut-out LPC. The temperature in the chambers slowly rises. The compressor starts automatically when suction pressure increases over the value set on the LPC.
5. If valves 4 or 5 and 6 /fig.8/ are closed - see point 4.
6. Valve 4 /fig.8/ serves as dehydrator's by pass, for e.g. in the event of its change or regeneration.
7. If valve 10 is closed /fig.8/ the compressor works with 50% of its capacity. Temperature in the chamber 2 slowly rises (the fan is on, the solenoid valve is open).
8. If valve 11 is closed /fig.8/ the compressor works with 50% of its capacity. Temperature in the chamber 1 slowly rises (the fan on, the solenoid valve open).
9. If valves 10 and 11 are closed /fig.8/ the compressor stops after decrease of suction pressure below the value set on the low pressure safety cut-out LPC, temperatures in chambers slowly rise.
10. The back pressure regulator BPR is set at a constant evaporator pressure in the chamber 2 corresponding to this chamber temperature level of 10 °C.

11. If valve 9 is closed /fig.8/ the condensing pressure p_k , condensing temperature t_k , and compression temperature t_t increase. If the value of compressing pressure exceeds the value set on the high pressure safety cut -out HPC then the compressor automatically stops. The high pressure alarm lamp 'EMERG.STOP HIGH PRESS' turns on and the alarm sounds. To repeat the compressor start - see procedure point 3.
12. The pressure - controlled valve 8 /fig.8/ maintains constant condensing pressure p_k , and constant condensing temperature t_k .

5. Stopping procedure

1. Close valve 3 on the installation diagram /fig.8/.
2. Wait until the compressor sucks off the refrigerant vapour from the installation and stops automatically (when the suction line pressure is lower than pressure set on low pressure safety cut-out LPC).
3. Suction pressure, notwithstanding valve 3 is closed, /fig.8/ increases after a few minutes up to a value making possible the compressor start.
4. The compressor sucks off the rest of the refrigerant vapour from installation and automatically stops.
5. After compressor stopping, close valves 5, 6, or 4 and 10,11 as well as 2.
6. Close valve 1 at the compression side and close valve 9 on the condenser.
7. Switch off the compressor by mouse clicking in the proximity of 'OFF' on 'COMPRESSOR' switch on the control panel. The lamps 'STAND BY' and 'OIL HEATER' turn off.
8. Switch off the condenser cooling water pump by mouse clicking in the proximity of 'OFF' on 'CONDENSER COOLING PUMP' switch (lamp 'START' turns off).
9. Turn off the main switch by mouse clicking in the proximity of 'OFF' on 'MAIN SWITCH' on the control panel.('START' lamp turns off as well as the ventilators and solenoids 'START' lamps).

6. Cold chamber 1 defrosting procedure

Defrosting is performed in deep refrigeration chamber 1. Defrosting is effectuated by using electric heaters. It may be carried out in automatic or manual cycle. The thermostat placed on the lowest evaporator coil signalizes when defrosting ends. The thermostat setting is constant, without a possibility of external changes. Defrosting takes place when temperature in the chamber 1 is below 0°C.

Automatic defrosting:

1. Set the defrosting timer on control panel /fig.1/ in order to determine defrosting frequency. This operation can be effectuated each 8 min. (timer set on 8), each 16 min. (timer set on 16) or each 24 min (timer set on 24).
2. After a period of time 8, 16 or 24 min. (according to the frequency set) the yellow lamp 'DEFROSTING START' turns on and subsequently the lamp 'START' of the solenoid valve and the fan in chamber 1 switch off. Next, the lamp 'EVAP. HEATER ON' turns on.
3. During defrosting operation, the chamber 1 temperature display turns red, indicating that defrosting proceeds.
4. When defrosting procedure is finished, the lamp 'EVAP. HEATER ON' turns off automatically and next, the lamp 'START' of the solenoid valve and the fan turn on.
5. Chamber 1 temperature display changes colours from red to blue.

Manual defrosting:

1. Press push- button 'MANUAL DEFROST.' on the control panel (by mouse clicking) /fig.1/.
2. The yellow lamp 'DEFROSTING START' turns on and the lamp 'START' of the solenoid valve and the fan in the chamber 1 switch off simultaneously. Next, the lamp 'EVAP. HEATER ON' turns on.
3. During defrosting operation, the chamber 1 (fig. 2) temperature display turns red, indicating that defrosting proceeds.
4. When defrosting procedure is finished, the lamp 'EVAP. HEATER ON' turns off automatically and next, the lamp 'START' of the solenoid valve and the fan turn on.
5. Chamber 1 temperature display changes colours from red to blue.

Attention:

1. During defrosting procedure 'EVAP. HEATER ON' the solenoid valve of chamber 1 is closed (the fan is off, the temperature in the chamber slowly rises).
2. During defrosting chamber 1, chamber 2 maintains normal automatic operation.

7. Low suction pressure (p_s) setting procedure

Suction pressure which makes the compressor stop is set on the low pressure safety cut-out LPC /fig.4/. The start compressor pressure values 'START' are marked on the right side of the LPC scale. This pressure setting is performed by mouse clicking on the adjustment screw

arrow field (on the right side). The values of the difference between compressor start pressure and compressor stop pressure 'DIFF' are marked on the scale on the left side of the LPC. This difference can be adjusted by mouse clicking in the difference adjustment tap arrow field (on the left side). Stop compressor pressure 'STOP' equals to the difference between start compressor pressure 'START' and differential 'DIFF' set in on the LPT scale.

STOP = START - DIFF

The pressure gauge placed close to LPT illustrates the dependence between the refrigerating medium R 22 evaporator temperature and the current evaporating pressure.

Attention:

1. Low pressure safety cut-out LPC diagram is opened by mouse clicking at LPC symbol field placed on the installation diagram. After adjustment, close the LPC zoom.
2. Compressor stopping pressure should be set on such level as to obtain demanded temperature in chambers. For this purpose, it is necessary to set pressure on LPC corresponding to the demanded temperature in chamber 1 but decreased by the temperature difference necessary for the heat exchange process. For example, a temperature of about 8°C (if evaporating temperature read from pressure gauge is -10°C, then the lowest temperature possible to obtain in the chamber is equal to -2°C).

8. Maximum compression pressure (p_t) setting procedure

The maximum admissible compression pressure is set on the high pressure safety cut-out HPC /fig.5/. The values of pressure are marked on the HPC scale. The maximum compression pressure can be set by mouse clicking in the arrow field (close to adjustment screw).

Attention:

1. The button 'RESET' will be active (it will unlock HPC) when compression pressure drops to 1,4 MPa.
2. In the program HPC is set at the compression pressure value recommended for refrigerating medium R 22 i.e. 1,8 MPa.
3. High pressure safety cut-out HPC /fig.5/ diagram is opened by mouse clicking at HPC symbol field placed on the installation diagram /fig.2/. After adjustment, close HPC zoom.

9. Differential pressure control DPC setting procedure

The difference between the oil pump compression pressure and compressor suction pressure is set by mouse clicking in the arrow field on DPC scale /fig.6/. In order to check whether the

DPC is properly functioning, press the button 'TEST' over DPC symbol, while the compressor is running. The compressor stops for a while, but after releasing the button 'TEST' it starts again.

Attention:

When setting pressure difference is inferior to 0,03 MPa, the compressor stops automatically after approximately 3 seconds.

10. Cold chamber temperature setting procedure

The value of the demanded temperature in the chamber is set on the chamber's thermostats. The temperature values are marked on the thermostat scale. The choice of a demanded temperature is done by mouse clicking in the arrow field in the upper part of thermostat. The scale of admissible temperature difference 'DIFF' - between actual temperature in the chamber and the set temperature - is placed in the down part of the thermostat. The difference of temperature adjustment is effectuated by mouse clicking in the arrow field placed under the temperature difference scale. The auxiliary diagram (helpful for proper temperature difference adjustment), is situated close to the thermostat. The temperature scale set on the thermostat is presented on the left side of the auxiliary diagram. The scale of values describing the temperature drop in the chamber is presented on the right side. The determined values describing the above difference are presented in the form of an angular line scale placed between left and right scale. The proper value to be set on the thermostat difference temperature scale 'DIFF' is obtained by crossing the lines connecting left and right scale with the central one.

Example:

The temperature set on the thermostat is equal to 10°C. By mouse clicking on the diagram field /fig. 1/, the line connecting the scale on the left side with the scale on the right, appears. In our example the line begins at the value of 10°C on the left scale. If we decide that the temperature decrease in the chamber will be equal to 2°C, in relation to the temperature set on thermostat, then we ought, by mouse clicking, to set the value of 2°C on right side of the diagram scale (the fan and the solenoid valve turn off at the temperature of $10 - 2 = 8^{\circ}\text{C}$). The numerical value on the scale in the middle of the diagram (in the described case equal to 4,5) is obtained by crossing the middle line with the lines connecting numbers 10 (left side scale) and 2 (right side scale). The obtained value should be set by mouse clicking on the arrows field below difference scale 'DIFF'.